

**WYLER**

# WYLER PRODUCTS AND SERVICES WYLER-PRODUKTE UND -SERVICES



**WYLER AG**  
INCLINATION MEASURING SYSTEMS  
NEIGUNGSMESSSYSTEME

Im Hölzli 13, CH - 8405 WINTERTHUR (Switzerland)  
+41 52 233 66 66  
wyler@wylerag.com  
www.wylerag.com

**Version 2024**  
Edition 1



INTRODUCTION

BLUESYSTEM II MODULAR

EINFÜHRUNG

Assemble your own set for your application ...

Stellen Sie Ihr Set für Ihre Anwendung zusammen ...



## SPECIFICATIONS

## BLUESYSTEM II MODULAR

## SPEZIFIKATIONEN

wylerLEVEL Frame  
160 mmwylerLEVEL Frame  
200 mm

TECHNICAL SPECIFICATIONS	wylerLEVEL Frame		TECHNISCHE SPEZIFIKATIONEN
Sensitivity	0.001 mm/m 0.2 arcsec		Zifferschritt看wert
Measuring range	±20 mm/m		Messbereich
Limits of error	max. 1% $M_W$ min. 0.001 mm/m		Fehlergrenze
$M_W$ = measured value			$M_W$ = Messwert
Temperature error / °C (Ø10 °C)	$M_W \leq 2$ mm/m max. 0.002 mm/m	$M_W > 2$ mm/m max. 0.020 mm/m	Temperaturkoeffizient / °C (Ø10 °C)
$M_W$ = measured value			$M_W$ = Messwert
Response time	< 5 sec		Einstelldauer

wylerLEVEL Frame 160 m

wylerLEVEL Frame 200 m

## TECHNICAL SPECIFICATIONS



## TECHNISCHE SPEZIFIKATIONEN

Digital output	RS232 / RS485, asynchronous, 7 DataBits, 2 StopBits, no parity, 9600 bps		Digitalausgang
Batteries size C Optional (rechargeable)	2 x 1.5 V Alkaline 2 x 1.2 V NiMH		Batterien Grösse C Alternative (wiederaufladbar)
External power supply	+5 V DC / +24 V DC		Externe Stromversorgung
Operating temperature	0 ... + 40 °C		Betriebstemperatur
Storage temperature	- 30 ... + 70 °C		Lagertemperatur
Net weight, including batteries	3600 g	4600 g	Netto-Gewicht, inklusive Batterien
- Length - Width - Height	160 mm 40 mm 160 mm	200 mm 40 mm 200 mm	- Länge - Breite - Höhe
Radio transmission Frequency	Bluetooth ISM Band / 2,4000 ... 2,4835 GHz		Funkübertragung Frequenz
Range of Bluetooth communication within BlueLEVEL Product line with free line of sight	ca. 35 m		Reichweite der Bluetooth Kommunikation innerhalb der BlueSYSTEM Produktlinie bei direkter Sichtverbindung

CE conformity

Meets emission and immunity requirements

Erfüllt die Standards für Emission und Störfestigkeit

CE-Konformität

## SPECIFICATIONS

## BLUESYSTEM II MODULAR

## SPEZIFIKATIONEN

Formats of value in display  
Darstellungsformate des Wertes  
in der Anzeige

wylerLEVEL Frame

Units

Decimals  
Dezimalstellen



Unit in display  
Einheit in der  
Anzeige

Einheiten

mm per m	2	xxxx.xx	mm/m	mm pro m
mm per m	3	xxx.xxx	mm/m	mm pro m
mm per m	4		mm/m	mm pro m
Inch per 10 inch	4	xx.xxxx	"/10"	Zoll pro 10 Zoll
Inch per 10 inch	4	xx.xxxx	"/12"	Zoll pro 10 Zoll
milli radian	2	xxxx.xx	mRad	Milli-Radian
milli radian	3	xxx.xxx	mRad	Milli-Radian
mm per relative base	2	xxxx.xx	mm/REL	mm pro relative Basis
mm per relative base	3	xxx.xxx	mm/REL	mm pro relative Basis
mm per relative base	4		mm/REL	mm pro relative Basis
Inch per relative base	4	xx.xxxx	"/REL	Zoll pro relative Basis
artillery per mill	2	xxxx.xx	A%0	Artillerie Promille
per mill	2	xxxx.xx	%0	Promille
per cent	3	xxx.xxx	%	Prozent
degree	1		DEG	Grad
degree	2		DEG	Grad
degree	3	xxx.xxx°	DEG	Grad
degree	4	xx.xxxx°	DEG	Grad
degree + arc minutes		xx°xx'	DEG	Grad + Bogenminuten
degree + arc minutes + arc seconds		xx°xx'xx"	DEG	Grad + Bogenminuten + Bogensekunden
arc minutes + arc seconds		xxxx'xx"	DEG	Bogenminuten + Bogensekunden
arc seconds		xxxxxx"	DEG	Bogensekunden
arc seconds	1	xxxxx.x"	DEG	Bogensekunden
centesimal degree	3	xxx.xxx	GON	Neugrad
centesimal degree	4		GON	Neugrad
slope		1/xxxx	SLOPE	Gefälle

EXAMPLE FOR THE DERIVATION OF A PRODUCT NUMBER

WYLERLEVEL FRAME

BEISPIEL FÜR DIE HERLEITUNG DER PRODUKTNUMMER

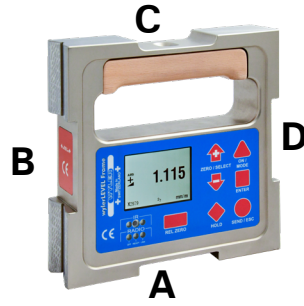

Structure of product number	ttt-bbb-ABCD-yyss	Aufbau einer Produktnummer
<b>Type of instrument</b>	<b>001</b> -bbb-ABCD-xyss 001 – wylerLEVEL 002 – wylerCLINO	<b>Gerätetyp</b>
<b>Length of base /mm</b>	ttt- <b>160</b> -ABCD-xyss 160 – 160 mm 200 – 200 mm	<b>Basenlänge /mm</b>
<b>Base type at position A, B, C and D</b>	ttt-bbb- <b>2211</b> -xyss  0 – No base 1 – flat 2 – prismatic 3 – flat with magnetic inserts 4 – prismatic with magnetic inserts	<b>Basistyp an Position A, B, C und D</b>  0 - keine Basis 1 - flach 2 - prismatisch 3 - flach mit magnetischen Einsätzen 4 - prismatisch mit magnetischen Einsätzen
	 A – 2 B – 2 C – 1 D – 1	
<b>Angle used for prismatic bases</b>	ttt-bbb-ABCD- <b>5</b> yss 0 - flat 5 – 150°	<b>Winkel der prismatischen Basis</b>
<b>Material of bases (housing)</b>	ttt-bbb-ABCD- <b>x2</b> ss 1 – cast iron 2 – cast iron, A and B scraped 3 – Aluminium	<b>Basenmaterial (Gehäuse)</b> 1 – Grauguss 2 – Grauguss, A und B geschabt 3 – Aluminium
<b>Sensitivity for LEVEL's</b>	ttt-bbb-ABCD-xy <b>AA</b> AA – 0.001 mm/m	<b>Zifferschnittwert für LEVEL's</b>
<b>Range for CLINO's</b>	10 – ±10° 60 – ±60°	<b>Messbereich für CLINO's</b>
<b>001-160-2211-52AA</b>		
<b>wylerLEVEL Frame</b> Cast iron Sensitivity 0.001 mm/m Base length 160 mm A – 150° prismatic, scraped B – 150° prismatic, scraped C – flat D – flat		<b>wylerLEVEL Frame</b> Grauguss Zifferschnittwert 0.001 mm/m Basislänge 160 mm A - 150° prismatisch, geschabt B - 150° prismatisch, geschabt C - flach D - flach

WYLERLEVEL FRAME

BLUESYSTEM II MODULAR

WYLERLEVEL FRAME

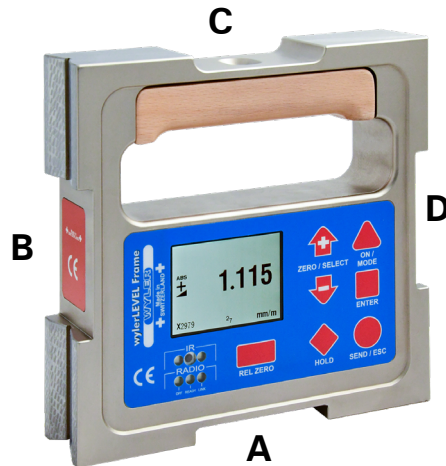
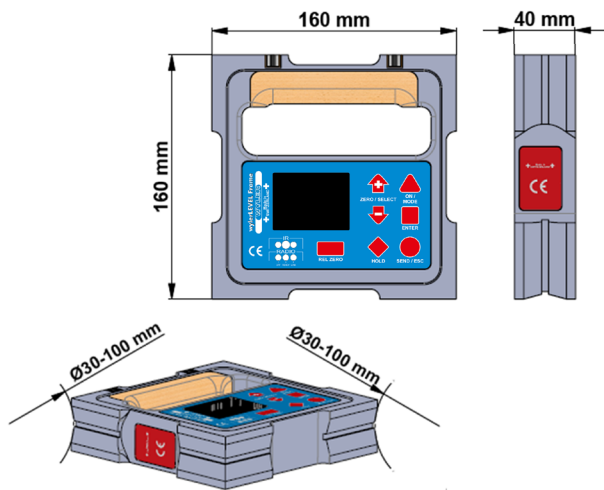

General

- Large graphical display
- Cast iron frame with 160 mm base length
- A and B contact faces hand scraped
- Prisms for shafts with Ø 30 ... 100 mm
- C and D contact faces grinded
- Other surfaces nickel-plated

Allgemein

- Grosse Grafikanzeige
- Grauguss-Rahmen mit 160 mm Basenlänge
- A und B Messflächen handgeschabt
- Prismen für Wellen mit Ø 30 ... 100 mm
- C und D Messflächen geschliffen
- Übrige Flächen vernickelt

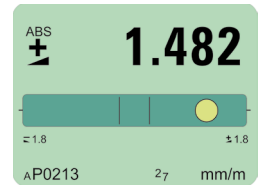
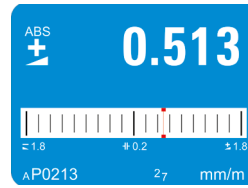
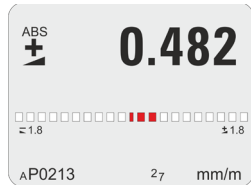
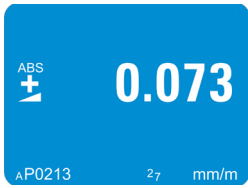

Prismatic Prismatisch				Flat Flach				Magnetic inserts Magneteinsätze				P/N Produktnummer
A	B	C	D	A	B	C	D	A	B	C	D	
X	X					X	X					001-160-2211-52AA
X	X					X	X		X	X	X	001-160-2433-52AA
				X	X	X	X					001-160-1111-02AA
				X	X	X	X		X	X	X	001-160-1333-02AA

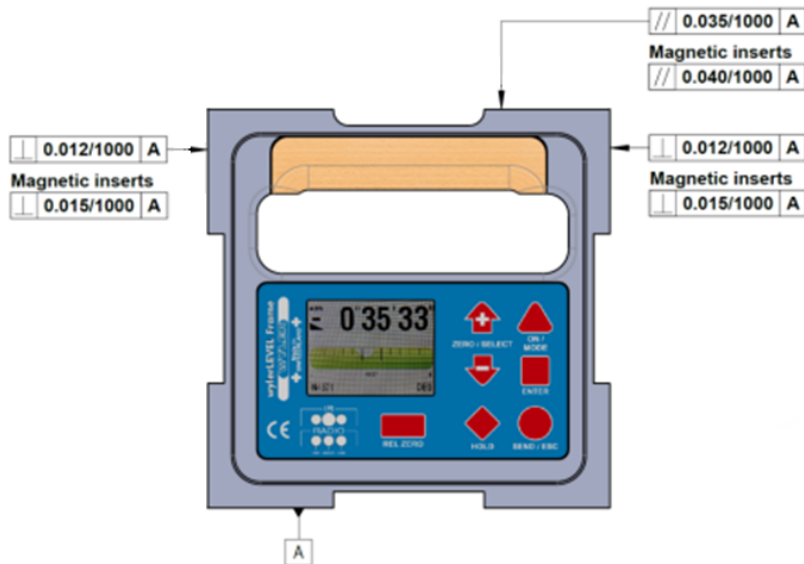

Scope of delivery

- 1 wylerLEVEL Frame, 160 mm
- 2 batteries 1.5V, size C

Lieferumfang

- 1 wylerLEVEL Frame, 160 mm
- 2 Batterien 1.5V, Grösse C

WYLERLEVEL FRAME

BLUESYSTEM II MODULAR

WYLERLEVEL FRAME

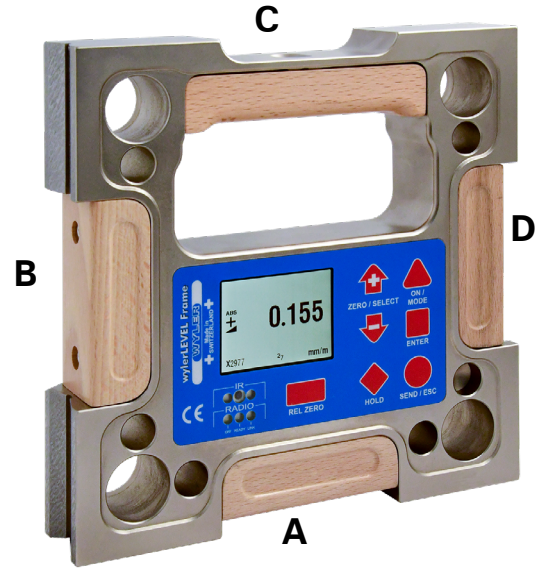
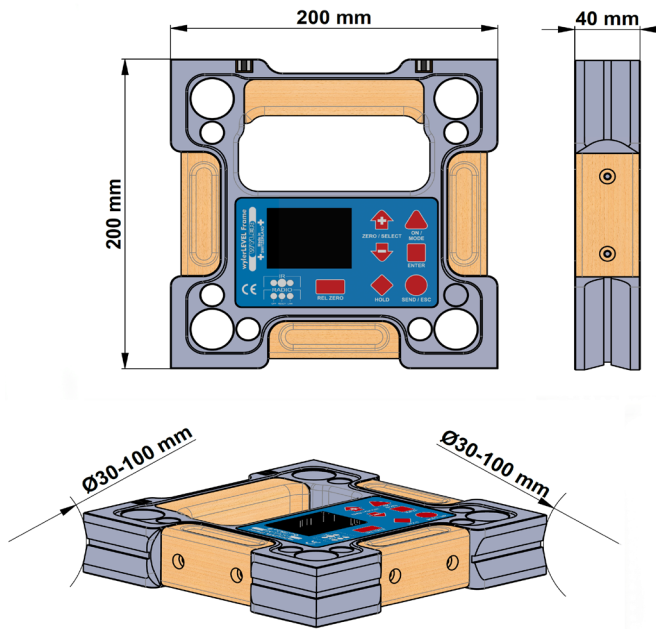

General

- Large graphical display
- Cast iron frame with 200 mm base length
- A and B contact faces hand scraped
- Prisms for shafts with Ø 30 ... 100 mm
- C and D contact faces grinded
- Other surfaces nickel-plated

Allgemein

- Grosse Grafikanzeige
- Grauguss-Rahmen mit 200 mm Basenlänge
- A und B Messflächen handgeschabt
- Prismen für Wellen mit Ø 30 ... 100 mm
- C und D Messflächen geschliffen
- Übrige Flächen vernickelt

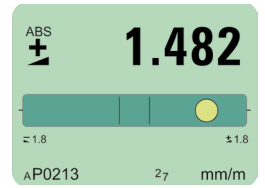
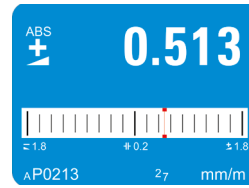
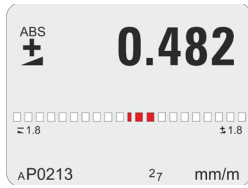
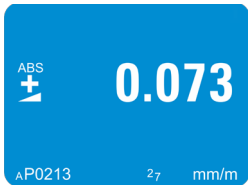

Prismatic Prismatisch		Flat Flach		Magnetic inserts Magneteinsätze			P/N Produktnummer	
A	B	C	D	A	B	C	D	
X	X						X	001-200-2211-52AA
X	X					X	X	001-200-2433-52AA
				X	X	X	X	001-200-1111-02AA
				X	X	X	X	001-200-1333-02AA

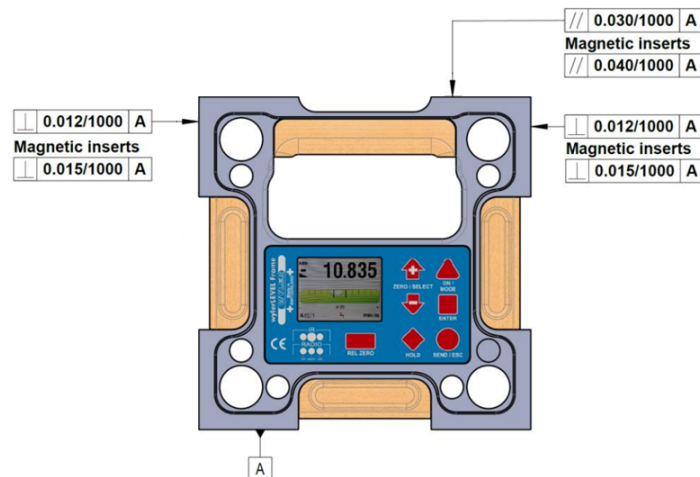





Scope of delivery

- 1 wylerLEVEL Frame, 200 mm
- 2 batteries 1.5V, size C

Lieferumfang

- 1 wylerLEVEL Frame, 200 mm
- 2 Batterien 1.5V, Grösse C

OPTIONS	BLUESYSTEM II MODULAR		OPTIONEN
Clean room version, available ONLY in combination with NEW order	P/N Produktnummer	Reinraumversion, verfügbar NUR im Zusammenhang mit NEU-Bestellung	
<p>In so called „clean room“- applications there are restrictions to use wood. We are therefore offering the wylerLEVEL Frame, wylerCLINO Frame, BlueLEVEL, BlueLEVEL-2D and the BlueMETER SIGMA with aluminum handle instead of a wooden handle. These options are only available in combination with NEW orders. Please add corresponding to product number to your choice of instrument.</p> <p>Aluminum handle in combination with new order for wylerLEVEL Frame or wylerCLINO Frame</p>	 <p>001-160-ALU</p>	<p>Holz darf in „Reinraum“ - Anwendungen nicht verwendet werden. Die wylerLEVEL Frame, wylerCLINO Frame, BlueLEVEL, BlueLEVEL-2D und BlueMETER SIGMA können deshalb optional mit einem Aluminium-Griff bestellt werden. Diese Optionen stehen nur in Kombination mit einer NEU-Bestellung zur Verfügung. Bitte fügen Sie die entsprechende Produktnummer Ihrem Gerätewunsch bei.</p> <p>Aluminiumgriff In Kombination mit Neubestellung für wylerLEVEL Frame oder wylerCLINO Frame</p>	
<p>Aluminum handle in combination with new order for BlueLEVEL</p>	 <p>016-BL-ALU</p>	<p>Aluminiumgriff In Kombination mit Neubestellung für BlueLEVEL</p>	
<p>Aluminum handle In combination with new order for BlueLEVEL-2D</p>	 <p>016-2D-ALU</p>	<p>Aluminiumgriff In Kombination mit Neubestellung für BlueLEVEL-2D</p>	
<p>Aluminum handle In combination with new order for BlueMETER SIGMA</p>	 <p>016-BM-ALU</p>	<p>Aluminiumgriff In Kombination mit Neubestellung für BlueMETER SIGMA</p>	

ACCESSORIES	BLUESYSTEM II MODULAR		ZUBEHÖR
-------------	-----------------------	--	---------

Batteries	Details	P/N Produktnummer	Batterien
<p>Battery (single) - size C</p>	 <p>1.5 V</p>	<p>604-065-C</p>	<p>Batterie (einzeln) - Grösse C</p>

P/N Produktnummer	
<p>wylerTRIGGER</p>	 <p>015-005-007</p> <p>wylerTRIGGER</p>





## ACCESSORIES

## BLUESYSTEM II MODULAR

## ZUBEHÖR

Universal cable RS485	Details	P/N Produktnummer	Universalkabel RS485
			
Male / male	2.5 m	029-025-878-001	Stecker / Stecker
Male / male	5 m	029-050-878-001	Stecker / Stecker
Male / male	10 m	029-100-878-001	Stecker / Stecker

Universal angular cable RS485 – one side, cable outgoing downwards	Details	P/N Produktnummer	Universal-Winkelkabel RS485 – eine Seite, Kabel nach unten wegführend
			
Male / male	2.5 m	029-025-878W001	Stecker / Stecker
Male / male	5 m	029-050-878W001	Stecker / Stecker
Male / male	10 m	029-100-878W001	Stecker / Stecker

Universal angular cable RS485 – one side, cable outgoing upwards	Details	P/N Produktnummer	Universalkabel RS 485 – eine Seite, Kabel nach oben wegführend
			
Male / male	2.5 m	029-025-878W003	Stecker / Stecker
Male / male	5 m	029-050-878W003	Stecker / Stecker
Male / male	10 m	029-100-878W003	Stecker / Stecker

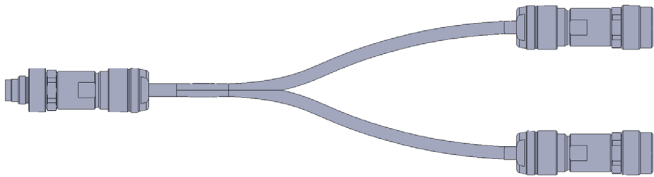
Universal Y-extension RS485	Details	P/N Produktnummer	Universal Y-Verlängerung RS485
			
Male / 2 female	0.4 m	029-004-878-Y	Stecker / 2 Buchsen

**ACCESSORIES** **BLUESYSTEM II MODULAR** **ZUBEHÖR**

**Remote Displays** **P/N Produktnummer** **Externe Anzeigen**

<p>BlueMETER SIGMA with radio transmission</p> <p>Remark: N O T compatible with BlueLEVEL II</p>	 <p><b>016F004-002</b></p>	<p>BlueMETER SIGMA mit Funkübertragung</p> <p>Hinweis: N I C H T kompatibel mit BlueLEVEL II</p>
--	---	--

License Lizenz	P/N Produktnummer	wylerPLOT
1.	<b>029-PLOT-L1</b>	
2.	<b>029-PLOT-L2</b>	

**Scope of delivery** **P/N Produktnummer** **Lieferumfang**

<p>Software per download from our website <a href="http://www.wylerag.com">www.wylerag.com</a></p> <p>Note: Software requires license management wylerCONNECT</p>	 <p>See above</p>	<p>Software downloadbar von unserer Webseite <a href="http://www.wylerag.com">www.wylerag.com</a></p> <p>Hinweis: Software benötigt Lizenzmanagement wylerCONNECT</p>
---	--	---

**Scope of delivery** **P/N Produktnummer** **Lieferumfang**

<p>Set with ...</p> <ul style="list-style-type: none"> <li>wylerCONNECT incl. license for separately ordered software</li> <li>wylerTRIGGER</li> <li>USB-C cable 1.4 m</li> <li>Universal cable 0.5 m</li> <li>Quick reference</li> </ul>	 <p><b>029-0001-001</b></p>	<p>Set mit ...</p> <ul style="list-style-type: none"> <li>wylerCONNECT inkl. Lizenz für separat bestellte Software</li> <li>wylerTRIGGER</li> <li>USB-C Kabel 1.4 m</li> <li>Universal Kabel 0.5 m</li> <li>Kurzanleitung</li> </ul>
<p>Set in storage case with ...</p> <ul style="list-style-type: none"> <li>wylerCONNECT incl. license for separately ordered software</li> <li>wylerTRIGGER</li> <li>USB-C cable 1.4 m</li> <li>Universal cable 0.5 m</li> <li>Quick reference</li> </ul>	 <p><b>029-0001-002</b></p>	<p>Set im Aufbewahrungskoffer mit ...</p> <ul style="list-style-type: none"> <li>wylerCONNECT inkl. Lizenz für separat bestellte Software</li> <li>wylerTRIGGER</li> <li>USB-C Kabel 1.4m</li> <li>Universal Kabel 0.5 m</li> <li>Kurzanleitung</li> </ul>

**Remote displays** **P/N Produktnummer** **Externe Anzeigen**

<p>Outdoor android based remote display with pre-installed APP wylerUNIVERSAL</p>	 <p><b>016-006-001</b></p>	<p>Outdoor Android basierte externe Anzeige mit vorinstallierter APP wylerUNIVERSAL</p>
---	---	---

ACCESSORIES **BLUESYSTEM II MODULAR** ZUBEHÖR

APP wylerUNIVERSAL

For Android version 11 and higher based devices.  
Ready for download from Google Playstore

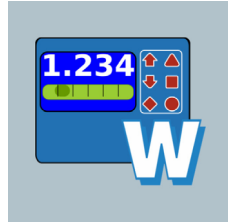

APP wylerUNIVERSAL

Für Android-Version 11 und höher basierte Geräte.  
Bereit zum Download im Google Playstore



<https://play.google.com/store/apps/details?id=com.wyler.wyleruniversal.wyler.wyler&gl=CH>

Working with the Full range of BlueSYSTEM II Modular

Arbeitet mit der gesamten Palette von BlueSYSTEM II Modular



The APP wylerUNIVERSAL reads two measuring channels from ONE or TWO WYLER measuring instruments, with this you read your values from the display of your Android device, which acts as remote display. This feature will help you to master following applications easier.

Die APP wylerUNIVERSAL liest zwei Messkanäle von EINEM oder ZWEI WYLER-Messgeräten aus, damit lesen Sie Ihre Werte vom Display Ihres Android-Geräts ab, das als externe Anzeige fungiert. Diese Funktion hilft Ihnen, folgende Anwendungen einfacher zu meistern.

Alignment of bigger machines and objects  
Analyze of pitch or roll movements

Ausrichten von größeren Maschinen und Objekten  
Analysieren von Nick- oder Rollbewegungen

Display

Darstellung

Vertical alignment

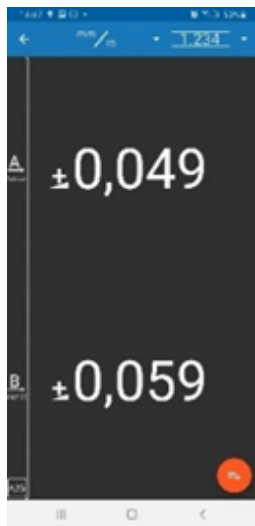

Ausrichtung vertikal

Horizontal alignment

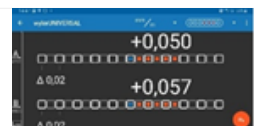
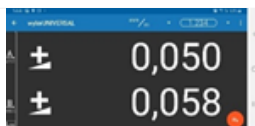

Ausrichtung horizontal

ACCESSORIES **BLUESYSTEM II MODULAR** ZUBEHÖR

APP wylerUNIVERSAL

APP wylerUNIVERSAL

For Android version 11 and higher based devices.  
Ready for download from Google Playstore

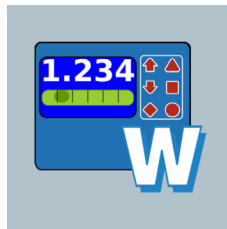

Für Android-Version 11 und höher basierte Geräte.  
Bereit zum Download im Google Playstore



<https://play.google.com/store/apps/details?id=com.wyler.wyleruniversal.wyler.wyler&gl=CH>

Display Anzeige

Units **mm/m** **° ' "** **"** **"/10"** **"/12"** Einheiten

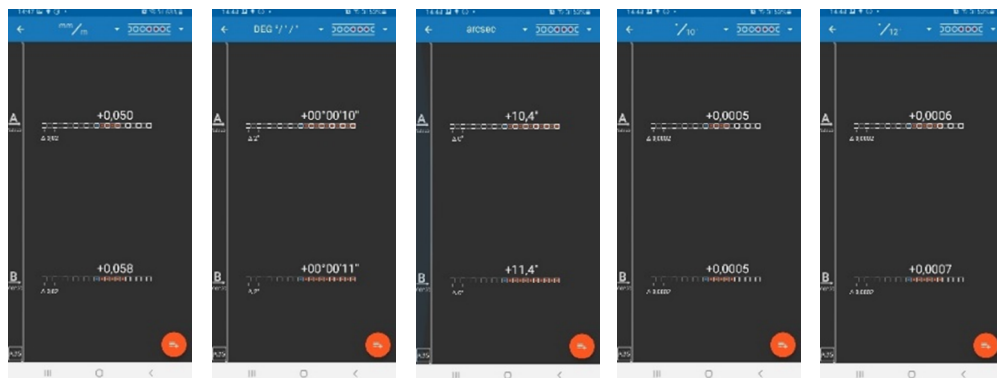

Functions Funktionen

Display

- Measuring value 1
- Measuring values 1 and 2
- Difference value (MV1 – MV2)

Darstellung

- Messwert 1
- Messwerte 1 und 2
- Differenz (MW1-MW2)

Saving measured values

1. Read in all measured values in rad with time stamp
2. create CSV file by adding
3. Transfer CSV file
4. Open CSV by EXCEL

	A	B	C
1	Date Time	S2323 [rad]	O0250 [rad]
2	07.09.2021 14:48	0,000050	0,000053
3	07.09.2021 14:48	0,000050	0,000053
4	07.09.2021 14:48	0,000050	0,000053
5	07.09.2021 14:48	0,000050	0,000053
6	07.09.2021 14:49	-0,000013	-0,000010
7	07.09.2021 14:49	-0,000098	-0,000094
8	07.09.2021 14:49	-0,001067	-0,000269
9	07.09.2021 14:49	-0,001112	-0,000472
10	07.09.2021 14:49	-0,000885	-0,000528
11	07.09.2021 14:49	-0,000271	-0,000554
12	07.09.2021 14:49	-0,000068	-0,000526
13	07.09.2021 14:49	0,000024	0,000023
14	07.09.2021 14:49	0,000050	0,000042
15	07.09.2021 14:49	0,000040	0,000047
16	07.09.2021 14:49	0,000044	0,000048
17	07.09.2021 14:49	0,000047	0,000049

Sichern von Messwerten

1. Einlesen aller Messwerte in Rad mit Zeitstempel
2. Erzeugen eines CSV File durch hinzufügen
3. Übertragen eines CSV File
4. Öffnen des CSV Files durch EXCEL

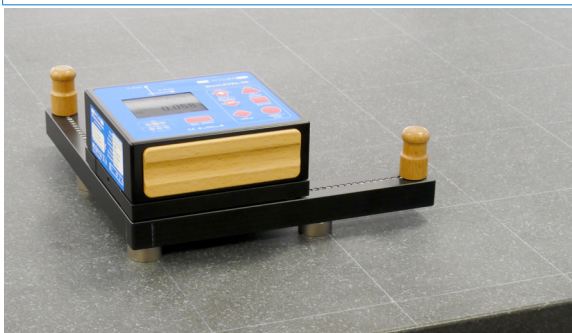

SOFTWARE PACKAGES **BLUESYSTEM II MODULAR** SOFTWARE-PAKETE

License Lizenz	P/N Produktnummer	Modules Module		
		1	4	
	1.	029-ELEMENTS-L1		
	2.	029-ELEMENTS-L2		

License Lizenz	P/N Produktnummer	Modules Module					
		1	2	3	4	8	
	1.	029-PROF-L1					
	2.	029-PROF-L2					
	Upgrade Wyler ELEMENTS	029-PROF-UP-F					

License Lizenz	P/N Produktnummer	Modules Module												
		1	2	3	4	5	6	7	8	9	10	11	12	
	1.	029-SPEC-L1												
	2.	029-SPEC-L2												
	Upgrade Wyler PROFESSIONAL	029-SPEC-UP-F												

System requirements	System-Anforderungen
Microsoft Windows WIN 10, 8 GB RAM, 4 Core, 1x USB 2.0 Optimized for resolution 1920x1080	

Scope of delivery	P/N Produktnummer	Lieferumfang
Software per download from our website <a href="http://www.wylerag.com">www.wylerag.com</a> Note: Software requires license management wylerCONNECT	See above Siehe oben 	Software downloadbar von unserer Webseite <a href="http://www.wylerag.com">www.wylerag.com</a> Hinweis: Software benötigt Lizenzmanagement wylerCONNECT

Scope of delivery	P/N Produktnummer	Lieferumfang
Set with ... <ul style="list-style-type: none"> <li>wylerCONNECT incl. license for separately ordered software</li> <li>wylerTRIGGER</li> <li>USB-C cable 1.4 m, Universal cable 0.5 m</li> <li>Quick reference</li> </ul>	<p>029-0001-001</p>	Set mit ... <ul style="list-style-type: none"> <li>wylerCONNECT inkl. Lizenz für separat bestellte Software</li> <li>wylerTRIGGER</li> <li>USB-C Kabel 1.4m, Universalkabel 0.5 m</li> <li>Kurzanleitung</li> </ul>
Set in storage case with ... <ul style="list-style-type: none"> <li>wylerCONNECT incl. license for separately ordered software</li> <li>wylerTRIGGER</li> <li>USB-C cable 1.4 m, Universal cable 0.5 m</li> <li>Quick reference</li> </ul>	<p>029-0001-002</p>	im Aufbewahrungskoffer mit ... <ul style="list-style-type: none"> <li>wylerCONNECT inkl. Lizenz für separat bestellte Software</li> <li>wylerTRIGGER</li> <li>USB-C Kabel 1.4m, Universalkabel 0.5 m</li> <li>Kurzanleitung</li> </ul>

**CASE** **BLUESYSTEM II MODULAR** **KOFFER**

**Available cases**  
 There are 4 cases of the sizes XL, L, M and S selectable.

**Verfügbare Koffer:**  
 Es stehen 4 Koffer der Größen XL, L, M und S zur Auswahl.

**XL**



**XL**

**DIMENSIONS**  
**WEIGHT**

**585 x 472 x 146 mm**  
**3.5 kg**

**DIMENSIONEN**  
**GEWICHT**

**L**



**L**

**DIMENSIONS**  
**WEIGHT**

**390 x 310 x 147 (51/96) mm**  
**1.6 kg**

**DIMENSIONEN**  
**GEWICHT**

**M**



**M**

**DIMENSIONS**  
**WEIGHT**

**300 x 275 x 110 (40/70) mm**  
**1.0 kg**

**DIMENSIONEN**  
**GEWICHT**

**S**



**S**

**DIMENSIONS**  
**WEIGHT**



















**255 x 210 x 60 (24/36) mm**  
**0.4 kg**

**DIMENSIONEN**  
**GEWICHT**

CASE - XL

BLUESYSTEM II MODULAR

KOFFER - XL

Location Ort	Space for ... Platz für ...	... or ... oder	... or ... oder	... or ... oder	... or ... oder	... or ... oder
1	 110 mm	 150 mm	 200 mm	 150 mm	 150 mm	 160 mm
2	 110 mm	 150 mm			 200 mm	
3						
4						
5						
6						
7						
8						
9				 200 mm		
10				 200 mm		
11				 150 mm		

Scope of delivery

P/N  
Produktnummer

Lieferumfang

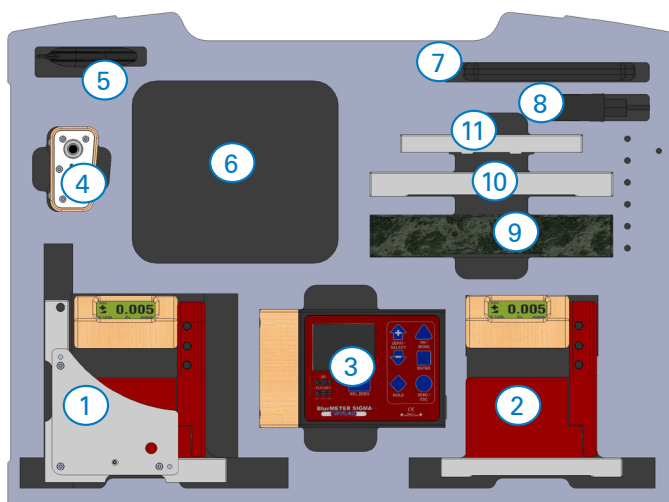

Case XL with  
Inlay for set with 2 BlueLEVEL, Version 1

















422-022B0006

Koffer XL mit  
Einlage für ein Set mit 2 BlueLEVEL, Version 1

CASE - XL

BLUESYSTEM II MODULAR

KOFFER - XL

Location Ort	Space for ... Platz für ...	... or ... oder	... or ... oder	... or ... oder	... or ... oder	... or ... oder
①	 110 mm	 150 mm	 200 mm	 150 mm	 150 mm	 160 mm
②	 110 mm	 150 mm	 200 mm	 150 mm	 150 mm	 160 mm
③						
④						
⑤	4x batteries, size C					
⑥	3x batteries, size C					
⑦	24V power supply					
⑧						

Scope of delivery

P/N  
Produktnummer

Lieferumfang

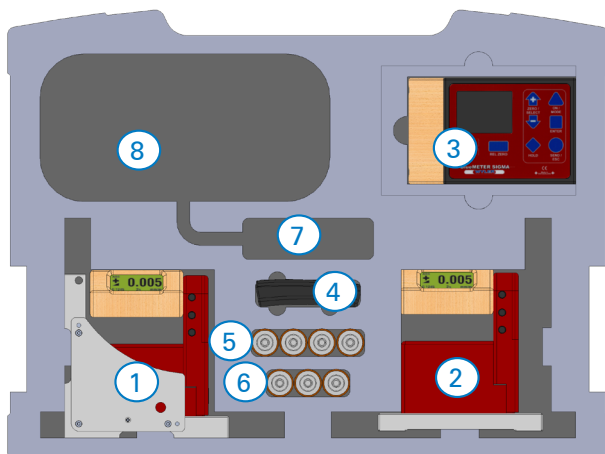

Case XL with  
Inlay for set with 2 BlueLEVEL, Version 2

422-022B0003







Koffer XL mit  
Einlage für ein Set mit 2 BlueLEVEL Version 2





CASE - XL

BLUESYSTEM II MODULAR

KOFFER - XL

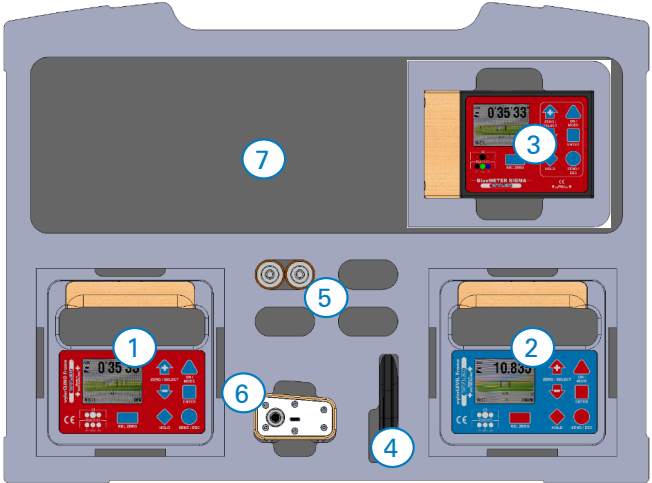







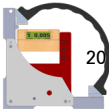

Location Ort	Space for ... Platz für ...
①	 160 mm
②	 160 mm
③	
④	
⑤	8x batteries, size C
⑥	
⑦	



Scope of delivery	P/N Produktnummer	Lieferumfang
	422-022B0019	

CASE - XL

BLUESYSTEM II MODULAR

KOFFER - XL

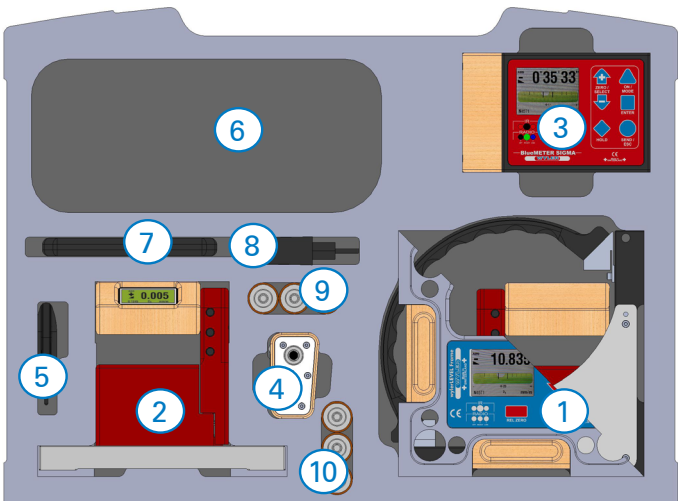













Location Ort	Space for ... Platz für ...	... or ... oder	... or ... oder
①	 200 mm	 200 mm	
②	 110 mm	 150 mm	 200 mm
③			
④			
⑤			
⑥			
⑦			
⑧			
⑨		3x batteries, size C	
⑩		3x batteries, size C	

Scope of delivery	P/N Produktnummer	Lieferumfang
	422-022B0011	
Case XL with Inlay for set with 2 BlueLEVEL, Version 4		Koffer XL mit Einlage für ein Set mit 2 BlueLEVEL, Version 4

CASE - L

BLUESYSTEM II MODULAR

KOFFER - L

Location Ort	Space for ... Platz für ...	... or ... oder	... or ... oder	... or ... oder	... or ... oder	... or ... oder	... or ... oder
1	 110 mm	 150 mm	 150 mm	 200 mm	 150 mm	 150 mm	 160 mm
2	 200 mm						
3	  4x batteries, size C						
4							
5							
6							
7							

Scope of delivery

P/N  
Produktnummer

Lieferumfang

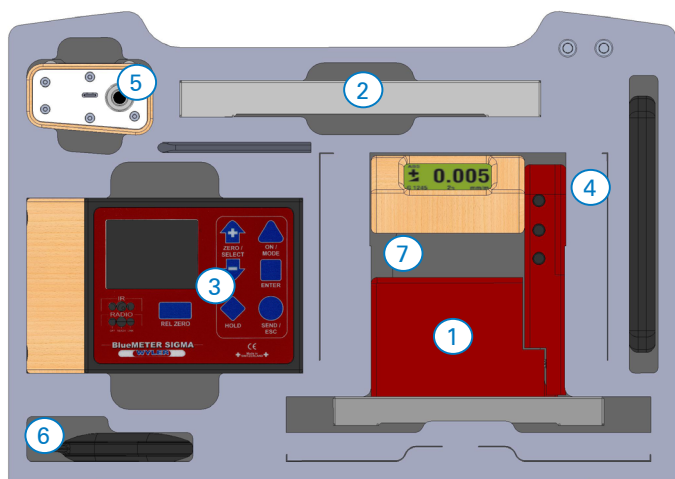

Case L with  
Inlay for 1 BlueLEVEL / wylerLEVEL Set





422-023B0003

Koffer L mit  
Einlage für ein Set mit 1 BlueLEVEL / wylerLEVEL

CASE - L

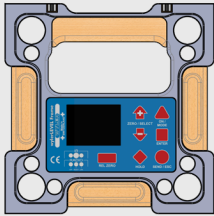
BLUESYSTEM II MODULAR

KOFFER - L

Location Ort	Space for ... Platz für ...
①	
②	 4x batteries, size C
③	
④	
⑤	

Scope of delivery	P/N Produktnummer	Lieferumfang
	422-023B0008	
Case L with Inlay for set with 1 wylerLEVEL Frame 200 mm	422-023B0008	Koffer L mit Einlage für ein Set mit 1 wylerLEVEL Frame 200 mm

CASE - M

BLUESYSTEM II MODULAR

KOFFER - M

Location Ort	Space for ... Platz für ...	... or ... oder	... or ... oder	... or ... oder	... or ... oder	... or ... oder
1	110 mm	150 mm	200 mm	150 mm	150 mm	160 mm
2	2 batteries, size C					
3						
4						
5						

Scope of delivery	P/N Produktnummer	Lieferumfang
	422-024B0003	
Case M with Inlay for 1 BlueLEVEL / wylerLEVEL		Koffer M mit Einlage für 1 BlueLEVEL / wylerLEVEL

SCS CERTIFICATE

SCS

SCS-ZERTIFIKAT

P/N  
Produktnummer

Calibration certificate

Kalibrierzertifikat



SCS calibration certificate for 1 electronic instrument as BlueLEVEL II, wylerLEVEL, wylerLEVEL Frame

SCS LEVEL 1D

SCS-Kalibrierzertifikat für 1 elektronisches Messgerät wie BlueLEVEL II, wylerLEVEL, wylerLEVEL Frame



SCS calibration certificate for 2 electronic instruments as BlueLEVEL II, wylerLEVEL, wylerLEVEL Frame in combination with BlueMETER SIGMA

SCS LEVEL 1D SET

SCS-Kalibrierzertifikat für 2 elektronische Messgeräte wie BlueLEVEL II, wylerLEVEL, wylerLEVEL Frame in Verbindung mit BlueMETER SIGMA



SCS calibration certificate for 1 BlueLEVEL-2D

SCS LEVEL 2D

SCS-Kalibrierzertifikat für 1 BlueLEVEL-2D

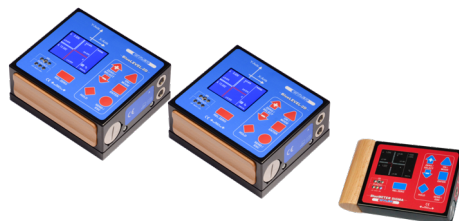

SCS calibration certificate for 2 BlueLEVEL-2D in combination with BlueMETER SIGMA

SCS LEVEL 2D SET

SCS-Kalibrierzertifikat für 2 BlueLEVEL-2D in Verbindung mit BlueMETER SIGMA



Quality

Service  
+ Partnership

Innovation  
+ Competence

Qualität

Service  
+ Partnerschaft

Innovation  
+ Kompetenz

WYLER SWITZERLAND is continuously enhancing their products and reserves the right to change technical specifications as well as the appearance without prior notice. For this reason the specifications and the pictures of the products delivered may be slightly different from those shown in the catalogue.

Die Firma WYLER AG ist stets um Produkteverbesserungen bemüht und behält sich das Recht vor, die technischen Daten und das äussere Erscheinungsbild jederzeit und ohne Vorankündigung zu ändern. Aus diesem Grund können die Spezifikationen und die Abbildungen der Produkte zum Teil leicht vom Katalog abweichen.



**WYLER AG**  
INCLINATION MEASURING SYSTEMS  
NEIGUNGSMESSSYSTEME

Im Hölderli 13, CH - 8405 WINTERTHUR (Switzerland)  
Tel. +41 (0) 52 233 66 66 Fax +41 (0) 52 233 20 53  
E-Mail: [wylers@wylers.com](mailto:wylers@wylers.com) Web: [www.wylers.com](http://www.wylers.com)

