

Our products at a glance

miniCATALOG

2026

Edition 1



miniCATALOGUS

Et overblik over vores produkter

Image videos

WYLER inclination measurement
Precise. Since 1928.



<https://vimeo.com/130540077>



Videofilm

WYLER-Neigungsmesssysteme -
Genau - Seit 1928.



<https://vimeo.com/145365769>

First imagefilm of WYLER AG,
english version 2011



<https://vimeo.com/124147284>

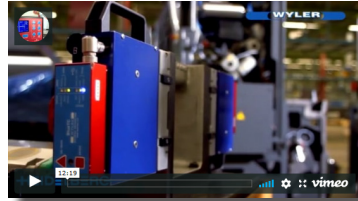

Erster Imagefilm der Firma WYLER AG,
deutsche Version 2011



<https://vimeo.com/124148942>



Excellence Class, Rhaetian Railways Landwasser Viaduct, Switzerland

Excellence Class, Rhaetian Railways Landwasser Viaduct, Schweiz

WYLER-Neigungsmesssysteme -
Genau - Seit 1928 (Kurzfassung Imagefilm)



<https://vimeo.com/181300236>



WYLER inclination measurement -
Precise. Since 1928 (abridged edition)



<https://vimeo.com/180401931>

WYLER傾斜度測量技術:
始自1928的精准
Chinese Version



<https://vimeo.com/190354382>

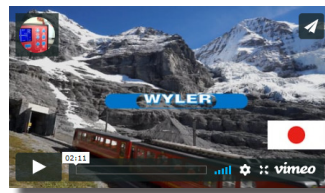
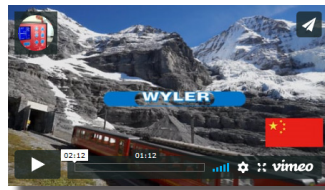

1928年から角度測定を追求してきた
スイス・ワイラー社
Japanese version



<https://vimeo.com/190354834>

WYLER는 1928년부터 고정밀 경사 측정 기술을 제
공해 왔습니다

Korean version



<https://vimeo.com/190355009>

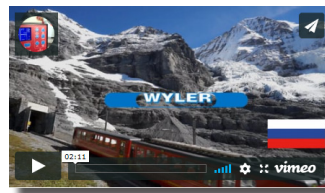
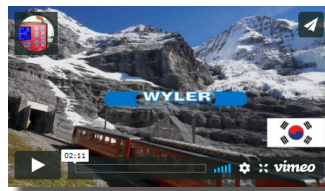

Система контроля отклонений WYLER:
точность с 1928 года

Russian version



<https://vimeo.com/190355118>

Technologie de mesure de l'inclinaison
WYLER : la précision depuis 1928
French version



<https://vimeo.com/190054490>

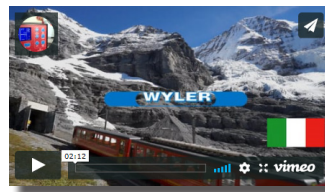

Tecnologia di misurazione dell'inclinazione
WYLER: precisione dal 1928
Italian version



<https://vimeo.com/190052687>

Tecnología de medición de la inclinación
WYLER: precisión desde 1928
Spanish version



<https://vimeo.com/190354558>



BlueLEVEL (II)



... are available in various configurations, with radio data transmission.

Main applications

- Precise alignment of objects
- Straightness measurement
- Parallelism measurement
- Flatness measurement
- Squareness measurement
- Rotation measurement PITCH and ROLL

... findes i forskellige konfigurationer, med radiodatatransmission.

Hovedapplikationer

- Præcis opretning af objekter
- Rethedsmåling
- Parallellitetsmåling
- Planhedsmåling
- Vinkelmåling
- Rotationsmåling PITCH og ROLL

Sensitivity Følsomhed	Range Måleområde
/ (mm/m)	/ (mm/m)
0.001	± 20

BlueLEVEL-2D



... combines 2 sensors for 2 axes measurements, with radio data transmission.

Main applications

- Precise alignment of objects
- Time saving 2-axis flatness measurement
- Rotation measurement PITCH and ROLL

... kombinerer 2 sensorer for 2-akset målinger, med radiodata transmission.

Hovedapplikationer

- Præcis opretning af objekter
- Tidsbesparende 2-akset planhedsmåling
- Rotationsmåling PITCH og ROLL

Sensitivity Følsomhed	Range Måleområde
/ (mm/m)	/ (mm/m)
0.001	± 20

wylerLEVEL Frame



... are available with radio data transmission.

Main applications

- Precise alignment of objects
- Straightness measurement
- Parallelism measurement
- Parallelism of opposite sides
- Flatness measurement
- Squareness measurement
- Rotation measurement PITCH and ROLL

... er tilgængelige med radiodatatransmission.

Hovedapplikationer

- Præcis opretning af objekter
- Rethedsmåling
- Parallellitetmåling
- Parallellitetsmåling af modstående sider
- Planhedsmåling
- Vinkelmåling
- Rotationsmåling PITCH og ROLL

Sensitivity Følsomhed	Range Måleområde
/ (mm/m)	/ (mm/m)
0.001	± 20

nivelSWISS



... is a standalone measurement instrument.

Main applications

- Precise alignment of objects
- Straightness measurement
- Parallelism measurement
- Squareness measurements

... er en „stand-alone“ måleenhed.

Hovedapplikationer

- Præcis opretning af objekter
- Rethedsmåling
- Parallellitetsmåling
- Vinkelmåling

Scale graduation Graduering af skala	Range Måleområde
/ (mm/m)	/ (mm/m)
0.010 / 0.050	± 0.150 / ± 0.750

wylerCLINO Frame 10°



... are available with radio data transmission. Same accuracy worldwide due to built-in gravity compensation.

Main applications

- Precise alignment of objects
- Straightness measurement
- Parallelism measurement
- Parallelism of opposite sides
- Flatness measurement
- Squareness measurements
- Rotation measurement PITCH and ROLL

... er tilgængelige med radiodatatransmission. Samme nøjagtighed på verdensplan på grund af indbygget tyngdekraftkompensation.

Hovedapplikationer

- Præcis opretning af objekter
- Rethedsmåling
- Parallellitetsmåling
- Parallellitetsmåling af modstående sider (ramme)
- Planhedsmåling
- Vinkelmåling
- Rotationsmåling PITCH og ROLL

Sensitivity Følsomhed	Limits of error within 12 months* (T _A = 20 °C) Grænser for fejl inden for 12 måneder* (T _A = 20 °C)	Range Måleområde
/ arcsec	/ arcsec	/ °
2	4 + 0.060 % M _w	± 10

M_w = measured value
T_A = ambient temperature
* typical value

M_w = målt værdi
T_A = omgivelsestemperatur
* typisk værdi



wylerCLINO Frame 60°



... are available with radio data transmission. Same accuracy worldwide due to built-in gravity compensation.

Main applications

- Alignment of objects
- Setting of large inclination angles

... er tilgængelige med radiodatatransmission. Samme nøjagtighed på verdensplan på grund af indbygget tyngdekraftkompensation.

Hovedapplikationer

- Opretning af objekter
- Indstilling af store hældningsvinkler

Sensitivity Følsomhed	Limits of error within 12 months* (T _A = 20 °C) Grænser for fejl inden for 12 måneder* (T _A = 20 °C)	Range Måleområde
/ arcsec	/ arcsec	/ °
5	15 + 0.027 % M _w	± 60

M_w = measured value
T_A = ambient temperature
* typical value

M_w = målt værdi
T_A = omgivelsestemperatur
* typisk værdi



Clinotronic S



... is equipped with radio data transmission. Same accuracy worldwide due to built-in gravity compensation.

... er udstyret med radiodatatransmission. Samme nøjagtighed på verdensplan på grund af indbygget tyngdekraftkompensation.

Main applications

- Alignment of objects
- Setting of large inclination angles

Hovedapplikationer

- Oprettning af objekter
- Indstilling af store hældningsvinkler

Sensitivity Følsomhed	Limits of error within 12 months* (T _A = 20 °C) Grænser for fejl inden for 12 måneder* (T _A = 20 °C)	Range Måleområde
/ arcsec	/ arcsec	/ °
5	0.055 % M _w / min. 15	± 45

M_w = measured value
T_A = ambient temperature
* typical value

M_w = målt værdi
T_A = omgivelsestemperatur
* typisk værdi

Clinotronic PLUS



... is a standalone measurement instrument.

... er et enkeltstående måleinstrument.

Main applications

- Alignment of objects
- Setting of large inclination angles

Hovedapplikationer

- Oprettning af objekter
- Indstilling af store hældningsvinkler

Sensitivity Følsomhed	Limits of error within 12 months* (T _A = 20 °C) Grænser for fejl inden for 12 måneder* (T _A = 20 °C)	Range Måleområde
/ arcsec	/ arcmin	/ °
5	1 ... 2 + 1 digit	± 45
5	1 ... 3 + 1 digit	± 60

T_A = ambient temperature
* typical value

T_A = omgivelsestemperatur
* typisk værdi

ZEROTRONIC



... sensors are compatible with BlueTC, MultiTC and BlueMETER SIGMA.

... Sensorer er kompatible med BlueTEC, Multi TC og Blue METER SIGMA.

Main applications

- Precise alignment of objects
- Straightness measurement
- Parallelism measurement
- Flatness measurement
- Squareness measurement
- Rotation measurement PITCH and ROLL
- Setting of large inclination angles
- Special measuring-base-adaptions
- Special adaptions, through size, weight or shock resistance

Hovedapplikationer

- Præcis oprettning af objekter
- Rethedsmåling
- Parallellitetsmåling
- Planhedsmåling
- Vinkelmåling
- Rotationsmåling PITCH og ROLL
- Indstilling af store hældningsvinkler
- Specielle målebase-tilpasninger
- Specielle tilpasninger gennem størrelse, vægt eller stødmotstand

Type Type	Resolution Løsning	Range Rækkevidde
	/ arcsec	/ °
ZEROTRONIC 3	0.1 ... 0.7	± 0.5
ZEROTRONIC 3	0.2 ... 0.9	± 1
ZEROTRONIC 3	0.7 ... 7.2	± 10
ZEROTRONIC C	3.2 ... 23.8	± 30
ZEROTRONIC C	3.2 ... 29.2	± 45
ZEROTRONIC C	4.3 ... 54	± 60

Types

ZEROTRONIC

Optioner



ZEROTRONIC HTR 10° Prisma

- Cast iron base
- Areas beside the measuring faces are nickel plated
- Measuring faces are scraped
- Housing aluminium
- Incl. ZEROTRONIC 3 HTR 10°

ZEROTRONIC HTR 10° Prisma

- Støbejernsbæse
- Området omkring målefladen er forniklet
- Målefladerne er præcision-skrabet
- Aluminiumshus
- Inkl. ZEROTRONIC 3 HTR 10°



wylerZERO Bus HTR 10°

- Stainless steel base
- Housing aluminium
- Incl. ZEROTRONIC 3 HTR 10°

wylerZERO Bus HTR 10°

- Rustfri stål-bæse
- Aluminiumshus
- Inkl. ZEROTRONIC 3 HTR 10°

Modular

ZEROTRONIC

Modul

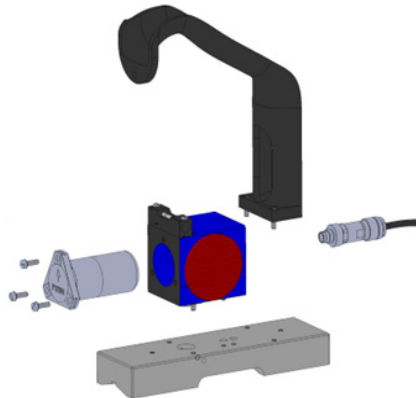

ZEROTRONIC horizontal modular

To adapt our ZEROTRONIC sensor easily to your application, you can define the combination of sensor and base.

Please follow these steps and choose

1. ZEROTRONIC sensor according to range and needed HTR compensation
2. a) Mounting block with no more options
b) Mounting block with further options at step 3. and 4.
3. Optional handle
4. Type and length of base
5. Accessories
6. Case

ZEROTRONIC vandret Modulær

For nemt at tilpasse vores ZEROTRONIC sensor til din applikation kan du definere kombinationen af sensor og base.

Følg venligst disse trin og vælg

1. ZEROTRONIC-sensor i henhold til rækkevidde og nødvendig HTR-kompensation
2. a) Monteringsblok uden flere muligheder
b) Monteringsblok med yderligere muligheder i trin 3. og 4.
3. Valgfrit håndtag
4. Type og længde af base
5. Tilbehør
6. Transportkasse

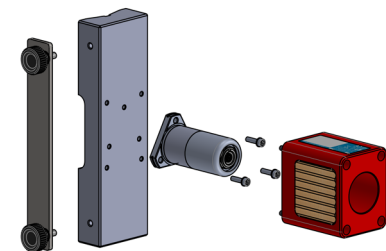

ZEROTRONIC vertical modular

To adapt our ZEROTRONIC sensor easily to your application, you can define the combination of sensor and base.

Please follow these steps and choose

1. ZEROTRONIC sensor according to range and needed HTR compensation
2. Housing with wooden or aluminum inlays
3. Type and length of base
4. Optional side stop
5. Accessories
6. Case

ZEROTRONIC lodret Modulær

For nemt at tilpasse vores ZEROTRONIC sensor til din applikation kan du definere kombinationen af sensor og base.

Følg venligst disse trin og vælg

1. ZEROTRONIC-sensor i henhold til rækkevidde og nødvendig HTR-kompensation
2. Hus med indlæg af træ eller aluminium
3. Type og længde af base
4. Valgfrit sidestop
5. Tilbehør
6. Transportkasse

ZEROMATIC



... sensors are compatible with MultiTC and BlueMETER SIGMA.

... Sensorer er kompatible med Multi TC og Blue METER SIGMA.

Main applications

- Precise alignment of objects
- Long term monitoring of objects in relation to absolute zero position

Hovedapplikationer

- Præcis opretning af objekter
- Langsigtet overvågning af objekter i forhold til absolut nulposition

Zero point limit of error after reversal measurement Nul-punktgrænse for fejl efter reverseringsmåling	Linearity limit of error within 6 months* Linearitetsgrænse for fejl inden for 6 måneder*	Range Rækkevidde
/ arcsec		/ °
1	0.5 % M _w	± 1

M_w = measured value
* typical value

M_w = målt værdi
* typisk værdi

BlueMETER SIGMA



... with or without radio data transmission. Can be used as a remote display for

... med radiodatatransmission. Kan bruges som en ekstern skærm til

- BlueLEVEL
- BlueLEVEL-2D
- wylerLEVEL (Frame)
- wylerCLINO (Frame)
- ZEROTRONIC
- ZEROMATIC

not compatible with BlueLEVEL II

- BlueLEVEL
- BlueLEVEL-2D
- wylerLEVEL (Frame)
- wylerCLINO (Frame)
- ZEROTRONIC
- ZEROMATIC

ikke kompatibel med BlueLEVEL II

LED CROSS

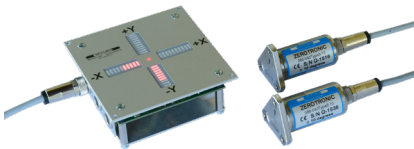

... is very suitable for providing a visual representation of the inclination of a platform.

... er meget velegnet til visuel gengivelse af platformens hældning.

Typical applications

- Supervision of a crane for goods that are sensitive to inclinations
- Optical aid for manual hydraulic levelling of objects or platforms

Typiske anvendelser

- Overvågning af en kran for gods som er følsomme overfor hældning
- Optisk hjælp til manuel hydraulisk nivellering af genstande eller platforme

wylerCONNECT



... with radio data transmission. Can be used for

... med radiodatatransmission. Kan bruges til

- BlueLEVEL
- BlueLEVEL II
- BlueLEVEL-2D
- wylerLEVEL Frame
- wylerCLINO Frame
- Clinotronic S (wireless only)
- ZEROTRONIC (cable only with MultiTC)
- ZEROMATIC (cable only with MultiTC)

- BlueLEVEL
- BlueLEVEL II
- BlueLEVEL-2D
- wylerLEVEL Frame
- wylerCLINO Frame
- Clinotronic S (kun via radiodatatransmission)
- ZEROTRONIC (kun kabel MultiTC)
- ZEROMATIC (kun kabel MultiTC)

MultiTC



... with data transmission by cable. Can be used for

... med datatransmission via kabel. Kan bruges til

- ZEROTRONIC
- ZEROMATIC

- ZEROTRONIC
- ZEROMATIC

wylerACCESS



... with wireless data transmission. Can be used for ... med radiodatatransmission. Kan bruges til

- ZEROTRONIC
- ZEROMATIC
- ZEROTRONIC
- ZEROMATIC

BlueTC



... with radio data transmission. Can be used for ... med radiodatatransmission. Kan bruges til

- ZEROTRONIC
- ZEROMATIC
- ZEROTRONIC
- ZEROMATIC

wylerSOFT



Status of installed software

- License
- Version
- Release notes
- Available download

Status for installeret software

- Licens
- Version
- Udgivelses noter
- Tilgængelig download

Support software tool

- wylerLICENSE to check and update all licenses
- wylerEXPLORER to check connectivity of instruments and sensors

Support softwareværktøj

- wylerLICENSE for at kontrollere og opdatere alle licenser
- wylerEXPLORER for at kontrollere forbindelsen mellem instrumenter og sensorer

wylerELEMENTS
wylerPROFESSIONAL
wylerSPEC

Geometry

Geometri

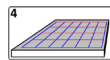
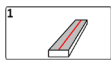

wylerELEMENTS

- Straightness
- Flatness

wylerELEMENTS

- Rethed
- Planhed

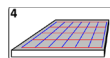
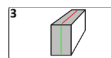
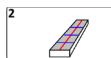
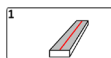

wylerPROFESSIONAL

- Straightness
- Straightness with twist
- Rectangularity
- Flatness
- Rotations

wylerPROFESSIONAL

- Rethed
- Rethed med twist
- Rektangulæritet
- Planhed
- Rotationer

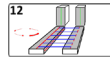
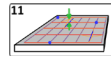
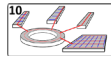
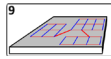
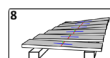
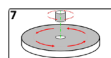
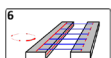
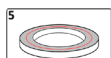
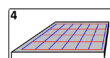
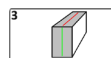
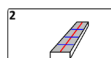

wylerSPEC

- Straightness
- Straightness with twist
- Rectangularity
- Flatness
- Circles
- Guide ways
- Vertical spindles
- Rotations
- Parallelism and coplanarity
- Own figures
- Trend
- Combination

wylerSPEC

- Rethed
- Rethed med twist
- Rektangulæritet
- Planhed
- Cirkler
- Guide måder
- Lodrette spindler
- Rotationer
- Parallellitet og koplanaritet
- Egne tal
- Tendens
- Kombination

Monitoring

wylerPLOT
wylerCHART
wylerDYNAM

Overvågning



wylerPLOT

wylerPLOT covers mainly the remote display functionality of the BlueMETER SIGMA.

wylerPLOT

wylerPLOT dækker hovedsageligt funktionaliteten af fjerndisplayet på BlueMETER SIGMA.



wylerCHART Lite

For up to two measuring channels, wylerCHART runs license-free. This functionality within wylerCHART is called wylerCHART Lite.

wylerCHART Lite

For op til to målekanaler kører wylerCHART licensfrit. Denne funktionalitet i wylerCHART kaldes wylerCHART Lite.

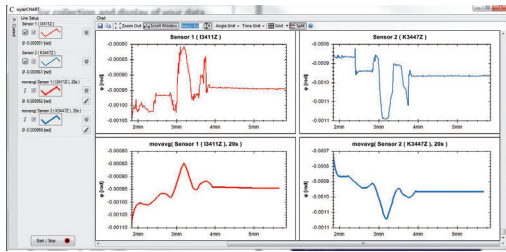

wylerCHART

Collects measuring data from WYLER inclination measuring instruments as ZEROTRONIC sensors. These measuring results can automatically be stored in a csv file and further processed with Excel.

wylerCHART

Indsamler måledata fra WYLER hældningsmåleinstrumenter som ZEROTRONIC sensorer. Disse måleresultater kan automatisk gemmes i en csv-fil og viderebehandles med Excel.



wylerDYNAM

wylerDYNAM offers a wide range of solutions, adaptable to all measuring tasks. With only a few clicks simple measuring tasks can be started. Thanks to its flexibility also complex measuring tasks can be solved.

wylerDYNAM

wylerDYNAM tilbyder løsninger, der kan tilpasses til en lang række måleopgaver. Med et par klik kan enkle måleopgaver startes. Takket være dets fleksibilitet kan også komplekse måleopgaver løses.

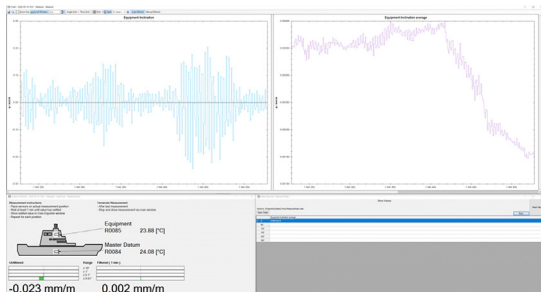

Includes the ready to use application SEATRONIC to measure parallelism on vessels.

Inkluderer den brugerklare SEATRONIC-applikation til måling af parallelitet på skibe.

Interface

wylerINSERT

Interface



wylerINSERT

wylerINSERT is an easy to use yet powerful tool to read inclination values from WYLER sensors and measuring instruments to insert them into any program at the current position of the cursor just like the values were typed in.

wylerINSERT

wylerINSERT er et brugervenligt, men alligevel kraftfuldt værktøj til at læse hældningsværdier fra WYLER-sensorer og indsætte dem i ethvert program ved markørens aktuelle position, ligesom værdierne blev indtastet.

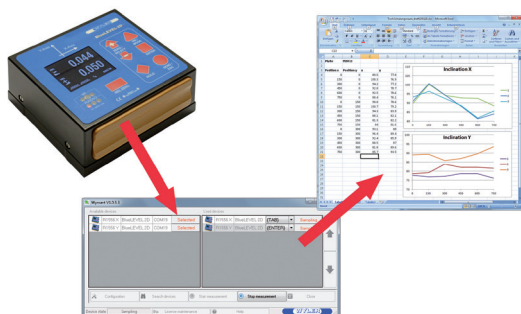

Horizontal spirit level

55 SPIRIT

Horizontal spirit level



Main applications

- Precise alignment of objects
- Straightness measurement
- Parallelism measurement

Hovedapplikationer

- Præcis opretning af objekter
- Rethedsmåling
- Parallellitetsmåling

Sensitivity Graduering af skala / (mm/m)	Range Måleområde / (mm/m)	Smallest Mindste	Length x Width x Height Længde x Bredde x Højde / mm	Biggest Største
0.02	± 0.06	100 x 32 x 35	300 x 50 x 51	
0.05	± 0.15			
0.10	± 0.30			
0.30	± 0.90			

Magnetic spirit level

48 SPIRIT

Magnetic spirit level



Main applications

- Precise alignment of objects
- Straightness measurement
- Parallelism measurement
- Squareness measurement

Hovedapplikationer

- Præcis opretning af objekter
- Rethedsmåling
- Parallellitetsmåling
- Vinkelmåling

Sensitivity Graduering af skala / (mm/m)	Range Måleområde / (mm/m)	Length x Width x Height Længde x Bredde x Højde / mm
0.02	± 0.06	150 x 40 x 150
0.05	± 0.15	
0.10	± 0.30	
0.30	± 0.90	

Precision frame spirit level

58 SPIRIT

Precision frame spirit level

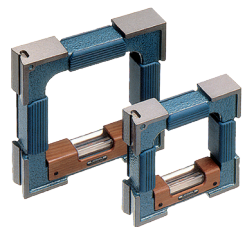

Main applications

- Precise alignment of objects
- Straightness measurement
- Parallelism measurement
- Parallelism of opposite sides
- Squareness measurement

Hovedapplikationer

- Præcis opretning af objekter
- Rethedsmåling
- Parallellitetsmåling
- Parallellitetsmåling af modstående sider
- Vinkelmåling

Sensitivity Graduering af skala / (mm/m)	Range Måleområde / (mm/m)	Smallest Mindste	Length x Width x Height Længde x Bredde x Højde / mm	Biggest Største
0.02	± 0.06	100 x 32 x 100	200 x 40 x 200	
0.05	± 0.15			
0.10	± 0.30			
0.30	± 0.90			

Adjustable spirit level

52

Adjustable spirit level



Main applications

- Precise alignment of objects within
- Straightness measurement
- Parallelism measurement

Hovedapplikationer

- Præcis opretning af objekter
- Rethedsmåling
- Parallellitetsmåling

Sensitivity Graduering af skala / (mm/m)	Range Måleområde / (mm/m)	Length x Width x Height Længde x Bredde x Højde / mm
0.02	0 ... 50 / ± 0.06	200 x 40 x 41
0.05	0 ... 50 / ± 0.15	
0.10	0 ... 50 / ± 0.30	

Adjustable micrometer spirit level

68

Adjustable micrometer spirit level



Main applications

- Precise alignment of objects
- Straightness measurement
- Parallelism measurement

Hovedapplikationer

- Præcis opretning af objekter
- Rethedsmåling
- Parallellitetsmåling

Sensitivity Graduering af skala / (mm/m)	Range Måleområde / (mm/m)	Length x Width x Height Længde x Bredde x Højde / mm
0.02	-20 ... 4 / ± 0.06	150 x 45 x 45 (80)

Crankpin spirit level

56

Crankpin spirit level



Main applications

- Measurements on pins of crank shafts

Hovedapplikationer

- Målinger af plejstænger på krumtapaksler

Sensitivity Graduering af skala / (mm/m)	Range Måleområde / (mm/m)		Smallest Mindste	Length x Width x Height Længde x Bredde x Højde / mm		Biggest Største
	A)	B)		A)	B)	
0.05	± 0.10	± 0.15	60 x 42 x 32	90 x 42 x 32		
0.10	± 0.20	± 0.30				

Shaft spirit level

63

Shaft spirit level



Main applications

- Precise alignment of objects
- Straightness measurement
- Parallelism measurement

Hovedapplikationer

- Præcis opretning af objekter
- Rethedsmåling
- Parallellitetsmåling

Sensitivity Graduering af skala / (mm/m)	Range Måleområde / (mm/m)	Smallest Mindste	Length x Width x Height Længde x Bredde x Højde / mm	Biggest Største
0.05	± 0.15	100 x 30 x 35	200 x 30 x 35	
0.10	± 0.30			
0.30	± 0.90			

Tubular spirit level

59

Tubular spirit level



Main applications

- Precise alignment of objects
- Straightness measurement

Hovedapplikationer

- Præcis opretning af objekter
- Rethedsmåling

Sensitivity Graduering af skala / (mm/m)	Range Måleområde / (mm/m)	Smallest Mindste	Length x Width / Diameter Længde x Bredde / Diameter / mm	Biggest Største
0.05	± 0.15	-----	200 x 11 / Ø22	
0.10	± 0.30	80 x 9 / Ø16		
0.30	± 0.90			

Screw-on spirit level

66

Screw-on spirit level



Main applications

- Alignment of objects
- Straightness measurement

Hovedapplikationer

- Opretning af objekter
- Rethedsmåling

Sensitivity Graduering af skala / (mm/m)	Range Måleområde / (mm/m)	Smallest Mindste	Length x Width x Height Længde x Bredde x Højde / mm	Biggest Største
0.10	± 0.20	80 x 15 x 18	150 x 18 x 22	150 x 18 x 22
0.30	± 0.30	60 x 12 x 14		
1.00	± 2.00	50 x 10 x 12	60 x 12 x 14	60 x 12 x 14
2 ... 5	-----	30 x 10 x 10		

Magnetic angle spirit level

47

Magnetic angle spirit level



Main applications

- Alignment of objects
- Straightness measurement

Hovedapplikationer

- Opretning af objekter
- Rethedsmåling

Sensitivity Graduering af skala / (mm/m)	Range Måleområde / (mm/m)	Length x Width x Height Længde x Bredde x Højde / mm
0.30	± 0.90	100 x 30 x 100

Universal angle spirit level

64

Universal angle spirit level



Main applications

- Alignment of objects (vertical and horizontal)
- Straightness measurement

Hovedapplikationer

- Opretning af objekter (lodret og vandret)
- Rethedsmåling

Sensitivity Graduering af skala / (mm/m)	Range Måleområde / (mm/m)	Length x Width x Height Længde x Bredde x Højde / mm
0.50	± 1.50	160 x 40 x 150

Cross spirit level

78

Cross spirit level



Main applications

- Alignment of objects

Hovedapplikationer

- Opretning af objekter

Sensitivity Graduering af skala / (mm/m)	Range Måleområde / (mm/m)	Length x Width x Height Længde x Bredde x Højde / mm
0.02	± 0.06	148 x 147 x 30
0.10	± 0.20	78 x 65 x 17
0.30	± 0.60	

Cross spirit level

76

Cross spirit level

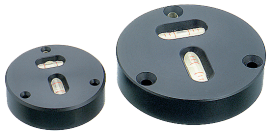

Main applications

- Alignment of objects

Hovedapplikationer

- Opretning af objekter

Sensitivity Graduering af skala	Range Måleområde	Smallest Mindste	Diameter x Height Diameter x Højde	Biggest Største
/ (mm/m)	/ (mm/m)		/ mm	
0.3	± 0.6	60 x 13		80 x 18
1.0	± 2.0			
2 ... 5	-----	40 x 11		-----

Circular spirit levels

72 / 73 / 74

Circular spirit levels



MOD. 72



MOD. 73



MOD. 74

Main applications

- Alignment of objects

Hovedapplikationer

- Opretning af objekter

Sensitivity Gradering af skala	Smallest Mindste	Diameter x Height Diameter x Højde	Biggest Største
/ arcmin		/ mm	
8 ... 12	60 x 17		-----
10 ... 20	16 x 10		30 x 14.5
12 ... 18	40 x 12		50 x 15
20 ... 30	20 x 9		30 x 11

Clinometer

80

Clinometer

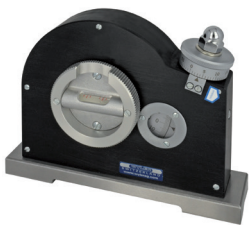

Main applications

- Alignment of objects (vertical and horizontal)
- Checking and setting of inclination angles

Hovedapplikationer

- Opretning af objekter (lodret og vandret)
- Kontrol og indstilling af hældningsvinkler

Sensitivity Graduering af skala / (mm/m)	Range Måleområde / °	Length x Width x Height Længde x Bredde x Højde / mm
0.30	± 180	150 x 35 x 116

Communicating water level

77

Communicating water level



Main applications

- Adjustment of two or more objects to the same level or determine their deviation in height within 0.05 mm

Hovedapplikationer

- Justering af to eller flere objekter til det samme niveau eller bestemme deres indbyrdes afvigelse i højden inden for 0,05 mm

Sensitivity (column) Graduering af skala (Säule)	Sensitivity (micrometer) Rækkevidde (mikrometer)	Diameter x Height (with micrometer) Diameter x Højde (med mikrometer)
/ mm	/ mm	/ mm
1	0.01	Ø100 x 250 (350)

Granite straight edges



264

Granit lige kant



Granite measuring and setting straight edges with two parallel faces

Måle- og Kontrollineal af granit med 2 parallelle flader

Length x Width x Height Længde x Bredde x Højde / mm	Weight Vægt / kg	DIN 874-3/000  / μm	WYLER 000  / μm
200 x 30 x 40	0.7	2.6	1.5
500 x 45 x 90	6	5	2.5
750 x 50 x 140	16	7	3.5
1000 x 56 x 160	26	9	4.5
1250 x 60 x 190	42	11	5.5
1500 x 70 x 220	69	13	6.5

Granite measuring squares



265

Granit måleplan



Granite measuring and setting square with two precise faces

Måle- og Kontrolvinkel af granit med 2 præcise flader

Length x Width x Height Længde x Bredde x Højde / mm	Weight Vægt / kg	DIN 874-3/000  / μm	WYLER 000  / μm
200 x 50 x 300	6.5	2.5	1.6
250 x 50 x 400	10	3	1.8
300 x 60 x 500	17	3.5	2
400 x 70 x 600	30	4	2.2

SCS certificates and services

Service muligheder

Calibration laboratory SCS WYLER AG

SCS

Calibration Laboratory SCS WYLER



High precision inclination measuring instruments have to be tested and recalibrated on a regular base. Our air-conditioned calibration lab is equipped with special high precision measuring and calibration equipment certified by METAS Switzerland. The calibration range for instruments and sensors reaches from very small angles (0.2 arcsec) to the full circle (360°). Our laboratory is equipped to test and calibrate WYLER as well as non-WYLER products.

Højpræcisionsmåleinstrumenter til hældning skal testes og kalibreres regelmæssigt. Vores kalibreringslaboratorium med aircondition er udstyret med specielt måle- og kalibreringsudstyr med høj præcision certificeret af METAS Schweiz. Kalibreringsområdet for instrumenter og sensorer når fra meget små vinkler (0,2 buesek) til den fulde cirkel (360 °). Vores laboratorium er udstyret til at teste og kalibrere WYLER såvel som produkter, der ikke er WYLER.

Training

Uddannelse



Basics and product training

- Basics on inclination measurement
- Product training for customers

Grundlæggende og produktuddannelse

- Grundlæggende om hældningsmåling
- Produkt Træning for kunderne

Innovation, quality, service, sustainability and social responsibility - since 1928.

Further information on WYLER products can be found on our website www.wylerag.com or obtained from one of our distribution partners.

Thank you for your interest in our products.



Innovation, kvalitet, service, bæredygtighed og socialt ansvar - siden 1928.

Yderligere information om WYLER-produkter kan findes på vores websted www.wylerag.com eller fås fra en af vores verdensomspændende distributionspartnere.

Tak for din interesse for vores produkter.

WYLER AG
Inclination Measuring Systems
Neigungsmesssysteme
Im Hölderli 13, 8405 Winterthur, Switzerland
Tel. +41 52 233 66 66
www.wylerag.com | wyler@wylerag.com

Løwener Industri Aps.
Gade: Smedeland 2
By: 2600 Glostrup
Tlf.: 0045 43200300
Fax.: 0045 43 430 359
www.loewener.dk | vl@loewener.dk

