

WYLER

Our products at a glance

miniCATALOG

2026

Edition 1



미니 카달로그

모든 제품을 한눈에 확인하세요

www.wylerag.com

WYLER inclination measurement
Precise. Since 1928.



<https://vimeo.com/130540077>



WYLER-Neigungsmesssysteme -
Genau - Seit 1928.



<https://vimeo.com/145365769>

First imagefilm of WYLER AG,
english version 2011



<https://vimeo.com/124147284>

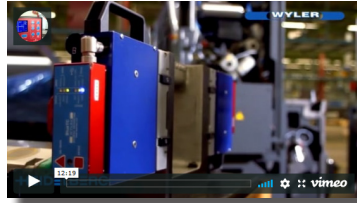

Erster Imagefilm der Firma WYLER AG,
deutsche Version 2011



<https://vimeo.com/124148942>



Excellence Class, Rhaetian Railways Landwasser Viaduct, Switzerland

빙하특급 열차, 란트바써 비아덕트 레티안 기차길, 스위스

WYLER-Neigungsmesssysteme -
Genau - Seit 1928 (Kurzfassung Imagefilm)



<https://vimeo.com/181300236>



WYLER inclination measurement -
Precise. Since 1928 (abridged edition)



<https://vimeo.com/180401931>

WYLER傾斜度測量技術:
始自1928的精准
Chinese Version



<https://vimeo.com/190354382>

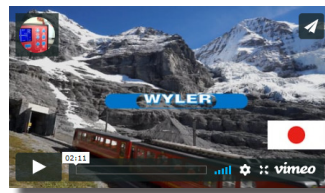
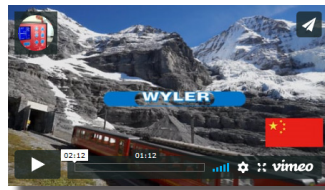

1928年から角度測定を追求してきた
スイス・ワイラー社
Japanese version



<https://vimeo.com/190354834>

WYLER는 1928년부터 고정밀 경사 측정 기술을 제
공해 왔습니다

Korean version



<https://vimeo.com/190355009>

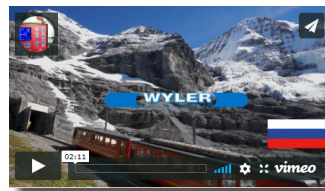
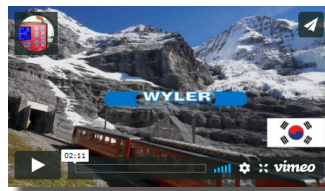

Система контроля отклонений WYLER:
точность с 1928 года

Russian version



<https://vimeo.com/190355118>

Technologie de mesure de l'inclinaison
WYLER : la précision depuis 1928
French version



<https://vimeo.com/190054490>

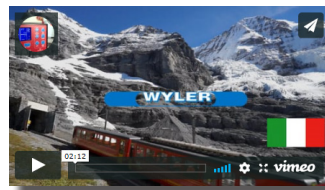

Tecnologia di misurazione dell'inclinazione
WYLER: precisione dal 1928
Italian version



<https://vimeo.com/190052687>

Tecnología de medición de la inclinación
WYLER: precisión desde 1928
Spanish version



<https://vimeo.com/190354558>

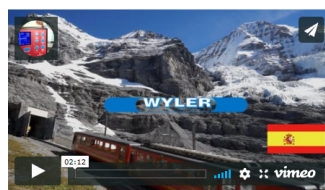

BlueLEVEL (II)



... are available in various configurations, with radio data transmission.

Main applications

- Precise alignment of objects
- Straightness measurement
- Parallelism measurement
- Flatness measurement
- Squareness measurement
- Rotation measurement PITCH and ROLL

... 다양한 구성으로 사용 가능 하며, 무선 기능이 포함 되어 있습니다.

주요 활용 분야

- 측정물의 정밀한 기울기 조정
- 진직도 측정
- 평행도 측정
- 평면도 측정
- 직각도 측정
- 피치와 롤 측정

Sensitivity 측정감도	Range 측정범위
/ (mm/m)	/ (mm/m)
0.001	± 20

BlueLEVEL-2D



... combines 2 sensors for 2 axes measurements, with radio data transmission.

Main applications

- Precise alignment of objects
- Time saving 2-axis flatness measurement
- Rotation measurement PITCH and ROLL

... 2축 측정을 위한 2개의 센서가 있으며, 무선 기능이 포함 되어 있습니다.

주요 활용 분야

- 측정물의 정밀한 기울기 조정
- 2축 동시 측정으로 평탄도 측정시 시간 절약 가능
- 피치와 롤 측정

Sensitivity 측정감도	Range 측정범위
/ (mm/m)	/ (mm/m)
0.001	± 20

wylerLEVEL Frame



... are available with radio data transmission.

Main applications

- Precise alignment of objects
- Straightness measurement
- Parallelism measurement
- Parallelism of opposite sides
- Flatness measurement
- Squareness measurement
- Rotation measurement PITCH and ROLL

... 무선 기능 사용이 가능 합니다.

주요 활용 분야

- 측정물의 정밀한 기울기 조정
- 진직도 측정
- 평행도 측정
- 상하 평행도 측정
- 평면도 측정
- 직각도 측정
- 피치와 롤 측정

Sensitivity 측정감도	Range 측정범위
/ (mm/m)	/ (mm/m)
0.001	± 20

nivelSWISS



... is a standalone measurement instrument.

Main applications

- Precise alignment of objects
- Straightness measurement
- Parallelism measurement
- Squareness measurements

... 단독으로 사용 가능한 전자수준기 입니다.

주요 활용 분야

- 측정물의 정밀한 기울기 조정
- 진직도 측정
- 평행도 측정
- 직각도 측정

Scale graduation 측정감도	Range 측정범위
/ (mm/m)	/ (mm/m)
0.010 / 0.050	± 0.150 / ± 0.750

wylerCLINO Frame 10°



... are available with radio data transmission. Same accuracy worldwide due to built-in gravity compensation.

Main applications

- Precise alignment of objects
- Straightness measurement
- Parallelism measurement
- Parallelism of opposite sides
- Flatness measurement
- Squareness measurements
- Rotation measurement PITCH and ROLL

... 무선 기능 사용이 가능 합니다. 중력값 보정 기능으로 전세계 어디에서나 동일한 정밀도를 보장 합니다.

주요 활용 분야

- 측정물의 정밀한 기울기 조정
- 진직도 측정
- 평행도 측정
- 상하 평행도 측정 (프레임)
- 평면도 측정
- 직각도 측정
- 피치와 롤 측정

Sensitivity 측정감도	Limits of error within 12 months* (T _A = 20 °C) 오차의 한계* (T _A = 20 °C)	Range 측정범위
/ arcsec	/ arcsec	/ °
2	4 + 0.060 % M _w	± 10

M_w = measured value
T_A = ambient temperature
* typical value

M_w = 측정 값
T_A = 주변 온도
* 대표값



wylerCLINO Frame 60°



... are available with radio data transmission. Same accuracy worldwide due to built-in gravity compensation.

Main applications

- Alignment of objects
- Setting of large inclination angles

... 무선 기능 사용이 가능 합니다. 중력값 보정 기능으로 전세계 어디에서나 동일한 정밀도를 보장 합니다.

주요 활용 분야

- 측정물의 기울기 조정
- 큰 기울기 각도 셋팅

Sensitivity 측정감도	Limits of error within 12 months* (T _A = 20 °C) 12개월 이내 오차의 한계* (T _A = 20 °C)	Range 측정범위
/ arcsec	/ arcsec	/ °
5	15 + 0.027 % M _w	± 60

M_w = measured value
T_A = ambient temperature
* typical value

M_w = 측정 값
T_A = 주변 온도
* 대표값



Clinotronic S



... is equipped with radio data transmission. Same accuracy worldwide due to built-in gravity compensation.

... 무선 기능이 포함되어 있습니다. 중력값 보정 기능으로 전세계 어디에서나 동일한 정밀도를 보장 합니다.

Main applications

- Alignment of objects
- Setting of large inclination angles

주요 활용 분야

- 측정물의 기울기 조정
- 큰 기울기 각도 셋팅



Sensitivity 측정감도	Limits of error within 12 months* (T _A = 20 °C) 12개월 이내 오차의 한계* (T _A = 20 °C)	Range 측정범위
/ arcsec	/ arcsec	/ °
5	0.055 % M _w / min. 15	± 45

M_w = measured value
T_A = ambient temperature
* typical value

M_w = 측정 값
T_A = 주변 온도
* 대표값

Clinotronic PLUS



... is a standalone measurement instrument.

... 단독으로 사용 가능한 전자수준기 입니다.

Main applications

- Alignment of objects
- Setting of large inclination angles

주요 활용 분야

- 측정물의 기울기 조정
- 큰 기울기 각도 셋팅

Sensitivity 측정감도	Limits of error within 12 months* (T _A = 20 °C) 12개월 이내 오차의 한계* (T _A = 20 °C)	Range 측정범위
/ arcsec	/ arcmin	/ °
5	1 ... 2 + 1 digit	± 45
5	1 ... 3 + 1 digit	± 60

T_A = ambient temperature
* typical value

T_A = 주변 온도
* 대표값

ZEROTRONIC



... sensors are compatible with BlueTC, MultiTC and BlueMETER SIGMA.

... 해당 센서는 BlueMETER SIGMA 및 BlueTC, MultiTC와 함께 사용이 가능 합니다.

Main applications

- Precise alignment of objects
- Straightness measurement
- Parallelism measurement
- Flatness measurement
- Squareness measurement
- Rotation measurement PITCH and ROLL
- Setting of large inclination angles
- Special measuring-base-adaptions
- Special adaptions, through size, weight or shock resistance

주요 활용 분야

- 측정물의 정밀한 기울기 조정
- 진직도 측정
- 평행도 측정
- 평면도 측정
- 직각도 측정
- 피치와 롤 측정
- 큰 기울기 각도 셋팅
- 맞춤형 스페셜 베이스 적용 가능
- 크기, 무게 또는 충격 저항력 등 맞춤 적용 가능

Type 타입	Resolution 분해능	Range 측정범위
	/ arcsec	/ °
ZEROTRONIC 3	0.1 ... 0.7	± 0.5
ZEROTRONIC 3	0.2 ... 0.9	± 1
ZEROTRONIC 3	0.7 ... 7.2	± 10
ZEROTRONIC C	3.2 ... 23.8	± 30
ZEROTRONIC C	3.2 ... 29.2	± 45
ZEROTRONIC C	4.3 ... 54	± 60

Types

ZEROTRONIC

타입



ZEROTRONIC HTR 10° Prisma	ZEROTRONIC HTR 10° Prisma
<ul style="list-style-type: none"> • Cast iron base • Areas beside the measuring faces are nickel plated • Measuring faces are scraped • Housing aluminium • Incl. ZEROTRONIC 3 HTR 10° 	<ul style="list-style-type: none"> • 주철 베이스 • 니켈 도금 처리된 옆면 • 스크래핑 처리된 측정면 • 알루미늄 하우징 • ZEROTRONIC 3 HTR 10° 포함



wylerZERO Bus HTR 10°	wylerZERO Bus HTR 10°
<ul style="list-style-type: none"> • Stainless steel base • Housing aluminium • Incl. ZEROTRONIC 3 HTR 10° 	<ul style="list-style-type: none"> • 스테인리스 스틸 베이스 • 알루미늄 하우징 • ZEROTRONIC 3 HTR 10° 포함

Modular

ZEROTRONIC

모듈식 구성

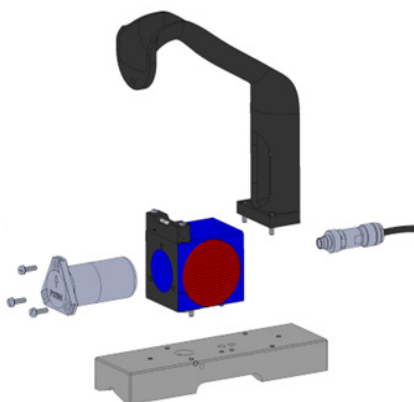

ZEROTRONIC horizontal modular	ZEROTRONIC 수평타입 모듈
<p>To adapt our ZEROTRONIC sensor easily to your application, you can define the combination of sensor and base.</p> <p>Please follow these steps and choose</p> <ol style="list-style-type: none"> 1. ZEROTRONIC sensor according to range and needed HTR compensation 2. a) Mounting block with no more options b) Mounting block with further options at step 3. and 4. 3. Optional handle 4. Type and length of base 5. Accessories 6. Case 	<p>ZEROTRONIC 센서를 귀사의 애플리케이션에 쉽게 적용시키기 위해, 센서와 베이스의 조합을 직접 구성하실 수 있습니다.</p> <p>아래의 절차를 따라 선택 하세요</p> <ol style="list-style-type: none"> 1. 측정 범위와 HTR 온도 보정 버전의 필요에 따라 Zerotron Sensor를 선택 2. a) 마운팅 블록 b) 3번, 4번 절차의 옵션이 포함된 마운팅 블록 3. 핸들 옵션 4. 베이스 타입과 길이 선택 5. 기타 액세서리 6. 케이스

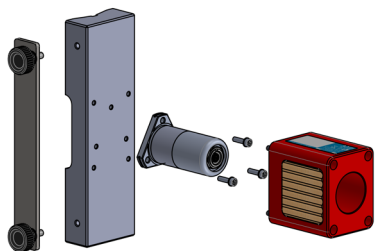

ZEROTRONIC vertical modular	ZEROTRONIC 수직타입 모듈
<p>To adapt our ZEROTRONIC sensor easily to your application, you can define the combination of sensor and base.</p> <p>Please follow these steps and choose</p> <ol style="list-style-type: none"> 1. ZEROTRONIC sensor according to range and needed HTR compensation 2. Housing with wooden or aluminum inlays 3. Type and length of base 4. Optional side stop 5. Accessories 6. Case 	<p>ZEROTRONIC 센서를 귀사의 애플리케이션에 쉽게 적용시키기 위해, 센서와 베이스의 조합을 직접 구성하실 수 있습니다.</p> <p>아래의 절차를 따라 선택 하세요</p> <ol style="list-style-type: none"> 1. 측정 범위와 HTR 온도 보정 버전의 필요에 따라 Zerotron Sensor를 선택 2. 목재 또는 알루미늄 인레이가 포함된 하우징 3. 베이스 타입과 길이 선택 4. 사이드 스탑 옵션 5. 기타 액세서리 6. 케이스

ZEROMATIC



... sensors are compatible with MultiTC and BlueMETER SIGMA.

... 해당 센서는 BlueMETER SIGMA, MultiTC와 함께 사용이 가능합니다.

Main applications

- Precise alignment of objects
- Long term monitoring of objects in relation to absolute zero position

주요 활용 분야

- 측정물의 정밀한 기울기 조정
- 해수면 기준으로 측정물의 장기적인 기울기 모니터링 가능

Zero point limit of error after reversal measurement 제로셋팅 후 제로 포인트에서 벗어나는 오차 한계	Linearity limit of error within 6 months* 6개월 이내 선형 오차 한계*	Range 측정범위
/ arcsec		/ °
1	0.5 % M _w	± 1

M_w = measured value
* typical value

M_w = 측정 값
* 대표값

BlueMETER SIGMA



... with or without radio data transmission. Can be used as a remote display for

... 무선으로 데이터 전송 가능. 다음의 기기를 위한 원격 디스플레이로 사용됨

- BlueLEVEL
- BlueLEVEL-2D
- wylerLEVEL (Frame)
- wylerCLINO (Frame)
- ZEROTRONIC
- ZEROMATIC

- BlueLEVEL
- BlueLEVEL-2D
- wylerLEVEL (Frame)
- wylerCLINO (Frame)
- ZEROTRONIC
- ZEROMATIC

not compatible with BlueLEVEL II

BlueLEVEL II 와 호환되지 않음

LED CROSS

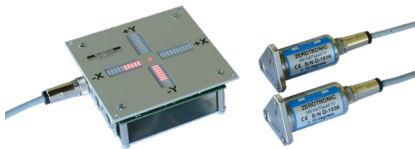

... is very suitable for providing a visual representation of the inclination of a platform.

...는 플랫폼의 기울기를 시각적으로 표현하는데 매우 적합합니다.

Typical applications

- Supervision of a crane for goods that are sensitive to inclinations
- Optical aid for manual hydraulic levelling of objects or platforms

주요 활용 분야

- 물품 운반을 위한 크레인의 기울기 감시
- 측정물 또는 플랫폼의 수동 수평 조정을 위한 광학 보조 장치

wylerCONNECT



... with radio data transmission. Can be used for

... 무선으로 데이터 전송 가능. 다음의 기기를 위한 송수신기로 사용됨

- BlueLEVEL
- BlueLEVEL II
- BlueLEVEL-2D
- wylerLEVEL Frame
- wylerCLINO Frame
- Clinotronic S (wireless only)
- ZEROTRONIC (cable only with MultiTC)
- ZEROMATIC (cable only with MultiTC)

- BlueLEVEL
- BlueLEVEL II
- BlueLEVEL-2D
- wylerLEVEL Frame
- wylerCLINO Frame
- Clinotronic S (무선 연결만 가능)
- ZEROTRONIC (MultiTC와 케이블로만 연결 가능)
- ZEROMATIC (MultiTC와 케이블로만 연결 가능)

MultiTC



... with data transmission by cable. Can be used for

... 케이블로 데이터 전송 가능. 다음의 기기를 위한 송수신기로 사용됨

- ZEROTRONIC
- ZEROMATIC

- ZEROTRONIC
- ZEROMATIC

wylerACCESS



... with wireless data transmission. Can be used for

... 무선으로 데이터 전송 가능. 다음의 기기를 위한 송수신기로 사용됨

- ZEROTRONIC
- ZEROMATIC

- ZEROTRONIC
- ZEROMATIC

BlueTC



... with radio data transmission. Can be used for

... 무선으로 데이터 전송 가능. 다음의 기기를 위한 송수신기로 사용됨

- ZEROTRONIC
- ZEROMATIC

- ZEROTRONIC
- ZEROMATIC

wylerSOFT



Status of installed software

- License
- Version
- Release notes
- Available download

설치된 소프트웨어 정보

- 라이선스
- 버전
- 업데이트 현황
- 다운로드 가능 자료

Support software tool

- wylerLICENSE to check and update all licenses
- wylerEXPLORER to check connectivity of instruments and sensors

소프트웨어 툴 지원

- wylerLICENSE 모든 라이선스 확인 및 업데이트
- wylerEXPLORER 기기와 센서 연결 상태 확인

Geometry

wylerELEMENTS
wylerPROFESSIONAL
wylerSPEC

기하학적 형상

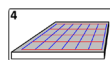
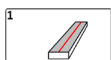

wylerELEMENTS

- Straightness
- Flatness

wylerELEMENTS

- 진직도
- 평면도

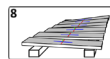
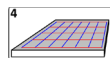
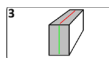
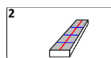
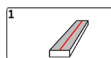

wylerPROFESSIONAL

- Straightness
- Straightness with twist
- Rectangularity
- Flatness
- Rotations

wylerPROFESSIONAL

- 진직도
- 진직도 및 트위스트 에러
- 직각도
- 평면도
- 피치를

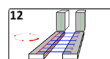
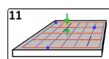
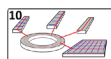
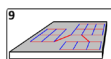
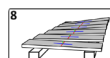
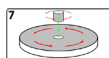
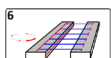
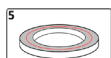
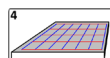
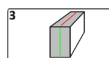
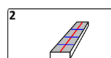

wylerSPEC

- Straightness
- Straightness with twist
- Rectangularity
- Flatness
- Circles
- Guide ways
- Vertical spindles
- Rotations
- Parallelism and coplanarity
- Own figures
- Trend
- Combination

wylerSPEC

- 진직도
- 진직도 및 트위스트 에러
- 직각도
- 평면도
- 서클
- 가이드웨이
- 수직 스피들
- 피치를
- 선 및 면의 평행도
- 특정 형상
- 트렌드
- 측정값 조합

Monitoring

wylerPLOT
wylerCHART
wylerDYNAM

모니터링



wylerPLOT

wylerPLOT covers mainly the remote display functionality of the BlueMETER SIGMA.

wylerPLOT

wylerPLOT 는 BlueMETER SIGMA 의 원격 디스플레이 기능을 대체합니다.



wylerCHART Lite

For up to two measuring channels, wylerCHART runs license-free. This functionality within wylerCHART is called wylerCHART Lite.

wylerCHART Lite

wylerCHART는 최대 2개의 측정 채널까지는 무료로 사용 가능 합니다. 무료 버전은 wylerCHART Lite로 wylerCHART 소프트웨어에 포함되어 있습니다.

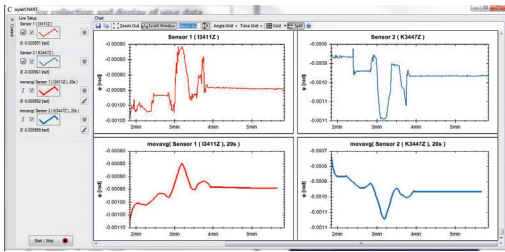

wylerCHART

Collects measuring data from WYLER inclination measuring instruments as ZEROTRONIC sensors. These measuring results can automatically be stored in a csv file and further processed with Excel.

wylerCHART

wylerCHART는 ZEROTRONIC 센서와 같은 기울기 측정 기기로부터 측정 데이터를 수집 합니다. 측정 결과는 CSV파일로 자동 추출되며 EXCEL로 변환하여 사용이 가능 합니다.



wylerDYNAM

wylerDYNAM offers a wide range of solutions, adaptable to all measuring tasks. With only a few clicks simple measuring tasks can be started. Thanks to its flexibility also complex measuring tasks can be solved.

wylerDYNAM

wylerDYNAM은 모든 측정 작업에 적용 가능한 광범위한 솔루션을 제공 합니다. 단 몇 번의 클릭 만으로도 간단한 측정 작업을 시작 할 수 있습니다. 뛰어난 유연성 덕분에 복잡한 측정 작업도 손쉽게 처리 할 수 있습니다.

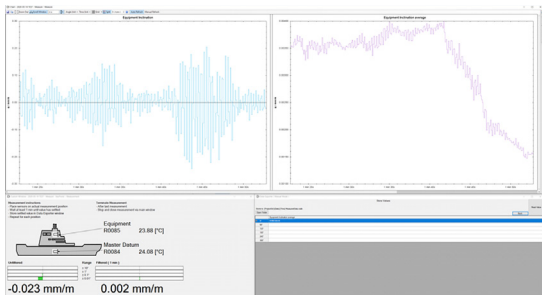

Includes the ready to use application SEATRONIC to measure parallelism on vessels.

해당 소프트웨어에는 선박 플랫폼의 평행도 측정이 가능한 SEATRONIC 응용 프로그램도 포함되어 있습니다.

Interface

wylerINSERT

인터페이스



wylerINSERT

wylerINSERT is an easy to use yet powerful tool to read inclination values from WYLER sensors and measuring instruments to insert them into any program at the current position of the cursor just like the values were typed in.

wylerINSERT

wylerINSERT는 측정값을 읽는 가장 손쉬우면서도 강력한 도구로 어떤 프로그램이라도 커서가 있는 위치에 측정값을 입력할 수 있습니다.

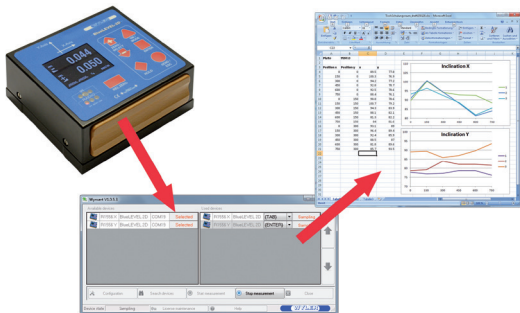

Horizontal spirit level

55 SPIRIT

수평식 기포관 수준기



Main applications

- Precise alignment of objects
- Straightness measurement
- Parallelism measurement

주요 활용 분야

- 측정물의 정밀한 기울기 조정
- 진직도 측정
- 평행도 측정

Sensitivity 측정감도 / (mm/m)	Range 측정범위 / (mm/m)	Smallest 최소 크기	Length x Width x Height 길이 x 너비 x 높이 / mm	Biggest 최대 크기
0.02	± 0.06	100 x 32 x 35	300 x 50 x 51	
0.05	± 0.15			
0.10	± 0.30			
0.30	± 0.90			

Magnetic spirit level

48 SPIRIT

마그네틱 기포관 수준기



Main applications

- Precise alignment of objects
- Straightness measurement
- Parallelism measurement
- Squareness measurement

주요 활용 분야

- 측정물의 정밀한 기울기 조정
- 진직도 측정
- 평행도 측정
- 직각도 측정

Sensitivity 측정감도 / (mm/m)	Range 측정범위 / (mm/m)	Length x Width x Height 길이 x 너비 x 높이 / mm
0.02	± 0.06	150 x 40 x 150
0.05	± 0.15	
0.10	± 0.30	
0.30	± 0.90	

Precision frame spirit level

58 SPIRIT

프레임 기포관 수준기

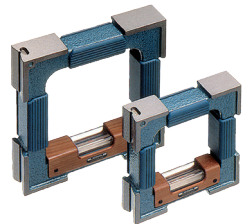

Main applications

- Precise alignment of objects
- Straightness measurement
- Parallelism measurement
- Parallelism of opposite sides
- Squareness measurement

주요 활용 분야

- 측정물의 정밀한 기울기 조정
- 진직도 측정
- 평행도 측정
- 상하 평행도 측정
- 직각도 측정

Sensitivity 측정감도 / (mm/m)	Range 측정범위 / (mm/m)	Smallest 최소 크기	Length x Width x Height 길이 x 너비 x 높이 / mm	Biggest 최대 크기
0.02	± 0.06	100 x 32 x 100	200 x 40 x 200	
0.05	± 0.15			
0.10	± 0.30			
0.30	± 0.90			

Adjustable spirit level

52

조정식 기포관 수준기



Main applications

- Precise alignment of objects within
- Straightness measurement
- Parallelism measurement

주요 활용 분야

- 측정물의 정밀한 기울기 조정
- 진직도 측정
- 평행도 측정

Sensitivity 측정감도 / (mm/m)	Range 측정범위 / (mm/m)	Length x Width x Height 길이 x 너비 x 높이 / mm
0.02	0 ... 50 / ± 0.06	200 x 40 x 41
0.05	0 ... 50 / ± 0.15	
0.10	0 ... 50 / ± 0.30	

Adjustable micrometer spirit level

68

조정식 마이크로미터 기포관 수준기



Main applications

- Precise alignment of objects
- Straightness measurement
- Parallelism measurement

주요 활용 분야

- 측정물의 정밀한 기울기 조정
- 진직도 측정
- 평행도 측정

Sensitivity 측정감도 / (mm/m)	Range 측정범위 / (mm/m)	Length x Width x Height 길이 x 너비 x 높이 / mm
0.02	-20 ... 4 / ± 0.06	150 x 45 x 45 (80)

Crankpin spirit level

56

크랭크 핀 기포관 수준기



Main applications

- Measurements on pins of crank shafts

주요 활용 분야

- 크랭크 샤프트 핀 위에서 측정 가능

Sensitivity 측정감도 / (mm/m)	Range 측정범위 / (mm/m)		Smallest 최소 크기	Length x Width x Height 길이 x 너비 x 높이 / mm		Biggest 최대 크기
	A)	B)		A)	B)	
0.05	± 0.10	± 0.15	60 x 42 x 32			90 x 42 x 32
0.10	± 0.20	± 0.30				

Shaft spirit level

63

샤프트 기포관 수준기



Main applications

- Precise alignment of objects
- Straightness measurement
- Parallelism measurement

주요 활용 분야

- 측정물의 정밀한 기울기 조정
- 진직도 측정
- 평행도 측정

Sensitivity 측정감도 / (mm/m)	Range 측정범위 / (mm/m)	Smallest 최소 크기	Length x Width x Height 길이 x 너비 x 높이 / mm	Biggest 최대 크기
0.05	± 0.15	100 x 30 x 35		
0.10	± 0.30			
0.30	± 0.90			

Tubular spirit level

59

튜브 기포관 수준기



Main applications

- Precise alignment of objects
- Straightness measurement

주요 활용 분야

- 측정물의 정밀한 기울기 조정
- 진직도 측정

Sensitivity 측정감도 / (mm/m)	Range 측정범위 / (mm/m)	Smallest 최소 크기	Length x Width / Diameter 길이 x 너비 / 직경 / mm	Biggest 최대 크기
0.05	± 0.15	-----	200 x 11 / Ø22	
0.10	± 0.30	80 x 9 / Ø16		
0.30	± 0.90			

Screw-on spirit level

66

나사 고정용 기포관 수준기



Main applications

- Alignment of objects
- Straightness measurement

주요 활용 분야

- 측정물의 기울기 조정
- 진직도 측정

Sensitivity 측정감도 / (mm/m)	Range 측정범위 / (mm/m)	Smallest 최소 크기	Length x Width x Height 길이 x 너비 x 높이 / mm	Biggest 최대 크기
0.10	± 0.20	80 x 15 x 18	150 x 18 x 22	150 x 18 x 22
0.30	± 0.30	60 x 12 x 14		
1.00	± 2.00	50 x 10 x 12	60 x 12 x 14	60 x 12 x 14
2 ... 5	-----	30 x 10 x 10		

Magnetic angle spirit level

47

마그네틱 앵글 기포관 수준기



Main applications

- Alignment of objects
- Straightness measurement

주요 활용 분야

- 측정물의 기울기 조정
- 진직도 측정

Sensitivity 측정감도 / (mm/m)	Range 측정범위 / (mm/m)	Length x Width x Height 길이 x 너비 x 높이 / mm
0.30	± 0.90	100 x 30 x 100

Universal angle spirit level

64

유니버설 앵글 기포관 수준기



Main applications

- Alignment of objects (vertical and horizontal)
- Straightness measurement

주요 활용 분야

- 측정물의 기울기 조정 (수직 및 수평)
- 진직도 측정

Sensitivity 측정감도 / (mm/m)	Range 측정범위 / (mm/m)	Length x Width x Height 길이 x 너비 x 높이 / mm
0.50	± 1.50	160 x 40 x 150

Cross spirit level

78

십자 기포관 수준기



Main applications

- Alignment of objects

주요 활용 분야

- 측정물의 기울기 조정

Sensitivity 측정감도 / (mm/m)	Range 측정범위 / (mm/m)	Length x Width x Height 길이 x 너비 x 높이 / mm
0.02	± 0.06	148 x 147 x 30
0.10	± 0.20	78 x 65 x 17
0.30	± 0.60	

Cross spirit level

76

십자 기포관 수준기

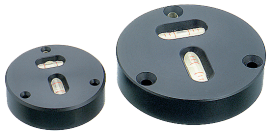

Main applications

- Alignment of objects

주요 활용 분야

- 측정물의 기울기 조정

Sensitivity 측정감도	Range 측정범위	Smallest 최소 크기	Diameter x Height 직경 x 높이	Biggest 최대 크기
/ (mm/m)	/ (mm/m)		/ mm	
0.3	± 0.6	60 x 13		80 x 18
1.0	± 2.0			
2 ... 5	-----	40 x 11		-----

Circular spirit levels

72 / 73 / 74

원형 기포관 수준기



MOD. 72

Main applications

- Alignment of objects

주요 활용 분야

- 측정물의 기울기 조정



MOD. 73

Sensitivity 측정감도	Smallest 최소 크기	Diameter x Height 직경 x 높이	Biggest 최대 크기
/ arcmin		/ mm	
8 ... 12	60 x 17		-----
10 ... 20	16 x 10		30 x 14.5
12 ... 18	40 x 12		50 x 15
20 ... 30	20 x 9		30 x 11



MOD. 74

Clinometer

80

클리노미터

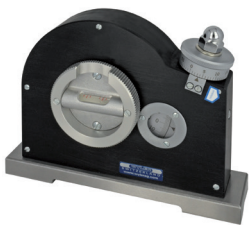

Main applications

- Alignment of objects (vertical and horizontal)
- Checking and setting of inclination angles

주요 활용 분야

- 측정물의 기울기 조정 (수직 및 수평)
- 기울기 각도의 정밀 셋팅 및 확인

Sensitivity 측정감도	Range 측정범위	Length x Width x Height 길이 x 너비 x 높이
/ (mm/m)	/ °	/ mm
0.30	± 180	150 x 35 x 116

Communicating water level

77

커뮤니케이팅 워터 레벨



Main applications

- Adjustment of two or more objects to the same level or determine their deviation in height within 0.05 mm

주요 활용 분야

- 둘 또는 그 이상의 측정물들의 기울기 또는 0.05mm 이하의 높이 차 확인

Sensitivity (column) 측정감도 (컬럼)	Sensitivity (micrometer) 측정감도 (마이크로미터)	Diameter x Height (with micrometer) 직경 x 높이 (마이크로미터 포함)
/ mm	/ mm	/ mm
1	0.01	∅100 x 250 (350)

Granite straight edges

264

스트레이트 엣지



Granite measuring and setting straight edges with two parallel faces

두개의 정밀 평행면으로 측정과 셋팅에 사용

Length x Width x Height 길이 x 너비 x 높이	Weight 무게	DIN 874-3/000  / μm	WYLER 000  / μm
/ mm	/ kg		
200 x 30 x 40	0.7	2.6	1.5
500 x 45 x 90	6	5	2.5
750 x 50 x 140	16	7	3.5
1000 x 56 x 160	26	9	4.5
1250 x 60 x 190	42	11	5.5
1500 x 70 x 220	69	13	6.5

Granite measuring squares



265

스퀘어



Granite measuring and setting square with two precise faces

두개의 정밀 면으로 스퀘어 측정과 셋팅에 사용

Length x Width x Height 길이 x 너비 x 높이	Weight 무게	DIN 874-3/000  / μm	WYLER 000  / μm
/ mm	/ kg		
200 x 50 x 300	6.5	2.5	1.6
250 x 50 x 400	10	3	1.8
300 x 60 x 500	17	3.5	2
400 x 70 x 600	30	4	2.2

SCS certificates and services

서비스

Calibration laboratory SCS WYLER AG

SCS

검교정 연구실 SCS WYLER



High precision inclination measuring instruments have to be tested and recalibrated on a regular base. Our air-conditioned calibration lab is equipped with special high precision measuring and calibration equipment certified by METAS Switzerland. The calibration range for instruments and sensors reaches from very small angles (0.2 arcsec) to the full circle (360°). Our laboratory is equipped to test and calibrate WYLER as well as non-WYLER products.

고정밀의 기울기 측정 장비들은 정기적인 테스트와 재보정 작업이 필요 합니다. 우리의 교정 연구소에서는 METAS Switzerland에서 인증한 특수 정밀 측정기 및 교정 장비가 구비 되어 있습니다. 계측기 및 센서의 교정 범위는 매우 작은 각도(0.2초)에서 완벽한 서클(360°)에 이릅니다. 우리 연구소는 WYLER 제품 뿐만 아니라 타사 제품도 교정이 가능 합니다.

Training

교육



Basics and product training

- Basics on inclination measurement
- Product training for customers

기초 이론 및 제품 교육

- 기울기 측정의 기본 이론
- 고객들을 위한 제품 사용자 교육

Innovation, quality, service, sustainability and social responsibility - since 1928.

Further information on WYLER products can be found on our website www.wylerag.com or obtained from one of our distribution partners.

Thank you for your interest in our products.

혁신, 품질, 서비스, 지속가능성과 사회적 책임 - 1928년부터.

WYLER 제품에 대한 자세한 정보는 당사 웹사이트(www.wylerag.com)에서 확인하시거나 전 세계에 있는 당사의 유통 파트너를 통해 얻으실 수 있습니다.

WYLER AG
Inclination Measuring Systems
Neigungsmesssysteme
Im Hölzli 13, 8405 Winterthur, Switzerland
Tel. +41 52 233 66 66
www.wylerag.com | wyler@wylerag.com

TAECHANG TRADING CORP 태창트레이딩
경기도 화성시 동탄첨단산업1로 27, IX타워 B
동 932,933호
031-508-9561
031-525-5200
www.tc-trading.com | sales@tc-trading.com