

Manual

BlueSYSTEM

BlueLEVEL – BlueMETER SIGMA – BlueTC



Two BlueLEVEL with BlueMETER SIGMA with wireless radio transmission for the data transmission

CONTENT

	Subject	Page
1	BASICS / INTRODUCTION	6
2	PREPARATION AND STARTUP OF THE MEASURING INSTRUMENTS	7
2.1	BATTERIES	7
2.1.1	INSERTING RESPECTIVELY REPLACEMENT OF BATTERIES IN BLUELEVEL	7
2.1.2	INSERTING RESPECTIVELY REPLACEMENT OF BATTERIES IN BLUEMETER SIGMA	7
2.1.3	INSERTING RESPECTIVELY REPLACEMENT OF BATTERIES IN BLUETC	7
2.2	INITIAL STARTUP OF THE INSTRUMENTS	8
2.3	CONNECTING THE INSTRUMENTS	9
2.3.1	CONNECTING THE BLUEMETER SIGMA	9
2.3.2	CONNECTING THE BLUETC	9
2.4	COMBINE A GROUP OF INSTRUMENTS TO A MEASUREMENT GROUP USING THE FUNCTION „JOIN“ IN RADIO TRANSMISSION MODE	10
2.4.1	PROCEDURE FUNCTION „JOIN“	10
2.4.2	PROCEDURE "JOIN" WITH WIRELESS DATA TRANSMISSION	11
2.4.3	SPECIAL CASES "JOIN"	12
2.5	UNHINGE AN INSTRUMENT IN THE RADIO MODE FROM A GROUP BY USING THE FUNCTION „LEAVE“	12
	PROCEDURE „LEAVE“	11
2.6	RENEWED CONNECTION OF A MEASURING GROUP	12
3	DESCRIPTION OF THE KEYS AND FUNCTION OF THE BLUELEVEL WITH AND WITHOUT RADIO TRANSMISSION	13
3.1	THE BLUELEVEL	13
3.2	VIEW OF FUNCTIONAL KEYS BLUELEVEL	14
3.2.1	REAR VIEW	14
3.2.2	TOP VIEW	14
3.3	FUNCTIONAL MENU WITH BLUELEVEL USING THE FUNCTION KEY	15
	ADDITIONAL FUNCTIONS	20
3.4	TEACH-IN OF THE IR-TRIGGER (ZAPPER)	20
3.5	OPERATING THE BLUELEVEL	21
3.5.1	DESCRIPTION OF THE VARIOUS KEYS	21
3.5.2	DESCRIPTION OF VARIOUS DISPLAY FORMS ON THE BLUELEVEL	25
4	DESCRIPTION OF THE BLUEMETER SIGMA WITH OR WITHOUT RADIO MODULE	27
4.1	START-UP OF THE BLUEMETER SIGMA	27
4.1.1	PREPARATION AND START-UP OF THE BLUEMETER SIGMA	27
4.1.1.1	OVERVIEW KEYBOARD AND DISPLAY	27
4.1.1.2	SWITCHING THE INSTRUMENT ON AND OFF	29
4.1.2	KEYS / FUNCTIONS / SHORT DESCRIPTIONS OF EACH SINGLE KEY	30
4.2	DISPLAY	32
4.2.1	SCALING OF THE DISPLAY	32
4.2.2	DISPLAY TYPES	32
4.2.3	BACKGROUND COLOUR	35
4.2.4	BRIGHTNESS OF THE DISPLAY	36
4.2.5	SHORT DESCRIPTION OF THE INDIVIDUAL DISPLAY AREAS	37
4.3	OPERATING INSTRUCTIONS BLUEMETER SIGMA	38
4.3.1	FUNCTIONS ON THE BLUEMETER SIGMA / OVERVIEW KEYS AND DISPLAY	38
4.3.2	STARTING THE BLUEMETER SIGMA	40
4.3.2.1	START WITH UNCHANGED CONFIGURATION	40
4.3.2.2	START WITH A CHANGED CONFIGURATION	41
4.4	REFRESH	42
4.5	SENSOR	42
4.6	ZERO-SETTING / ABSOLUTE ZERO	44
4.6.1	SET ABSOLUTE ZERO (WITH A REVERSAL MEASUREMENT)	44
4.7	SELECTION OF THE MEASURING UNIT / UNIT	46
4.7.1	STANDARD-UNITS	46
4.7.2	UNITS WITH RELATIVE BASE LENGTH	46
4.8	FUNCTION HOLD	47
4.9	SELECTION OF THE FILTER UNDER DIFFERENT MEASURING CONDITIONS / FILTER	48
4.10	ABSOLUTE MEASUREMENT / RELATIVE MEASUREMENT	48
4.10.1	ABSOLUTE MEASUREMENT	48
4.10.2	RELATIVE MEASUREMENT / REL ZERO	49
4.11	MEASURING WITH LIMITS / LIMITS	51
4.12	GROUPING AND UNHINGING OF A MEASURING GROUP (JOIN/LEAVE)	53

4.12.1	PROCEDURE "JOIN" VIA CABLE CONNECTION	53
4.12.2	PROCEDURE "JOIN" WITH WIRELESS DATA TRANSMISSION	54
4.12.3	SPECIAL CASES "JOIN"	55
4.12.4	UNHINGE AN INSTRUMENT IN THE RADIO MODE FROM A GROUP BY USING THE FUNCTION „LEAVE“	55
4.12.5	RENEWED CONNECTION OF A MEASURING GROUP	55
4.13	TEACH-IN OF THE IR-TRIGGER (ZAPPER)	56
5	OPTIONS	57
5.1	SET PIN-CODE	58
5.2	DISPLAY SETTINGS	58
5.3	LOGSCALE	59
5.4	PROGRAMMABLE KEYS	60
5.5	FUNCTIONS ON/OFF	61
5.6	HIDE DISABLED FUNCTIONS ON/OFF	61
5.7	RADIO ON/OFF	62
5.8	AUTO DEVICEADDRESS ON/OFF	62
5.9	CHANGING SENSOR ADDRESSES	62
5.10	GRAVITATION	64
5.11	VERSION FIRMWARE	65
5.12	FACTORY RESET	65
5.13	FUNCTION CHECK	66
6	BLUETC (TRANSCIVER/CONVERTER) WITH OR WITHOUT RADIO MODULE	67
6.1	INITIAL STARTUP OF THE BLUETC	67
6.2	TYPICAL CONFIGURATIONS WITH BLUETC	68
6.3	OVERVIEW OF THE BLUETC	68
6.4	FUNCTIONAL MENU WITH BLUETC / STRUCTURE	69
6.5	OPERATING THE BLUETC	70
	DESCRIPTION OF THE VARIOUS KEYS	70
	APPENDIX	71
A	BASICS ANF GENERAL REMARKS ABOUT BLUESYSTEM AND INCLINATION MEASUREMENT	71
A1	INTRODUCTION TO THE BLUESYSTEM	71
A2	DIFFERENCE BETWEEN THE CONFIGURATION WITH BLUEMETER AND BLUETC	72
A3	INSTRUMENT'S OVERVIEW	73
	THE INSTRUMENTS OF THE BLUESYSTEM - FAMILY IN DETAIL	73
B	EXAMPLE USING THE HYPER TERMINAL OF WINDOWS OR WINDOWS TERMINAL PROGRAM (EXAMPLE IS WIN XP)	75
C	SPECIAL FUNCTIONS	77
C1	RESET TO FACTORY PRE-SETTINGS	77
C2	FIRMWARE VERSION	77
C3	ACTIVATE THE FUNCTION KEY ON THE BLUETC	78
D	TECHNICAL DATA BLUESYSTEM	79
D1	TECHNICAL DATA OF THE RADIO MODULES	79
D2	TECHNICAL DATA OF THE BLUELEVEL	79
D3	TECHNICAL DATA OF THE BLUEMETER	80
D4	TECHNICAL DATA OF THE INTERFACE BLUETC	80
D5	PIN-DEFINITION FOR BLUELEVEL + BLUEMETER, BLUELEVEL + BLUEMETER BASIC AND BLUETC	81
E	SERVICE AND REPAIR	82
E1	REPAIR OF MEASURING INSTRUMENTS AND DISPLAY UNITS	82
E2	SERVICE- AND MAINTENANCE CONTRACTS	83
F	STORAGE OF THE INSTRUMENTS / CARE AND HANDLING OF THE BATTERIES	84
F1	STORAGE OF THE INSTRUMENTS	84
F2	CARE AND HANDLING OF THE BATTERIES	84
G	ACCREDITATION BLUETOOTH™ WIRELESS TECHNOLOGY FOR BLUESYSTEM	85
G1	MANUFACTURERS DECLARATION OF CONFORMITY (DoC)	85
G2	BLUETOOTH EQUIPMENT	86
G3	FCC COMPLIANCE	86
G4	COUNTRY SPECIFIC INFORMATION FOR BLUETOOTH RADIO LINK (>10mW RF-POWER)	87
H	FLOWCHARTS	90
I	FLOAT CHARTS OPTIONS	102
K	INDEX / KEYWORDS	116

MODIFICATIONS / ÄNDERUNGEN:

Date	Modified by	Description of modifications
19.7.2013	MG	Additional symbols described, new unit in BlueLEVEL

The following **additional manuals** may be downloaded from <http://www.wylerag.com>:

- **DYNAM**, the software for measuring and monitoring data delivered by the ZEROTRONIC-sensors
- **LEVELSOFT PRO**, the software for measuring flatness and inclination with WYLER inclination measuring instruments
- **MT-SOFT**, that gives the possibility to measure individual elements of machine tools with standard inclination measuring instruments. The measured results can be saved and at a later stage used for comparison and put together to receive a thorough result of the **over all accuracy of the machine tool**.
- **COMPENDIUM**, the guide to our products, technology and to a variety of applications.
- **Description of the interface RS485**

If for any reason it is not possible to download the respective data we will gladly supply against a nominal charge a CD "**ALL-IN-ONE**" with all the manuals in different languages included

1. BASICS / INTRODUCTION

The new **BlueSYSTEM** is a continuous further enhancement of the well known and well established measuring instruments MINILEVEL NT + LEVELTRONIC NT with or without wireless data transmission. A BlueSYSTEM normally consists of one or two measuring instruments BlueLEVEL and a display unit BlueMETER SIGMA. Depending on the application the BlueMETER SIGMA can also be connected to a PC with evaluation software allowing the online evaluation and presentation of the values.

The BlueSYSTEM is available with or without radio transmission. When using the system with cable connections it is possible to upgrade to wireless transmission at a later stage.

As its predecessor this newest generation of high precision electronic inclination measuring instruments is specifically suitable for the precision measurement of smallest angles. Applications are therefore in particular the measurement of flatness of surface plates or the measurement of the geometry of machine tools. The sensor itself, the heart of every precision measuring instrument, has been further enhanced as well, to allow precise measurements even under critical environmental conditions.

The new measuring instruments of the BlueSYSTEM family can be used as individual instruments as well as combined in a set. Instead of using a BlueMETER SIGMA it is also possible to use a BlueTC as an interface to the PC/Laptop. The functions are all the same with the exception of the LCD display which is only available with the BlueMETER SIGMA.

The BlueSYSTEM also forms part of the WyBus. Therefore a wide variety of other WYLER sensors can be integrated in the BlueSYSTEM: For instance the BlueMETER SIGMA can read the measuring values of ZEROTRONIC sensors or it can serve as a command and adjustment tool for ZEROMATIC sensors.

A set of instruments, also called **ENGINEER SET**, normally consists of one or two BlueLEVEL(s) and one BlueMETER SIGMA, forming the ideal tool for measuring flatness and machines under work shop conditions. Furthermore the ENGINEER SET can be used for any levelling task or analysis of rotations.

2 PREPARATION AND START-UP OF THE MEASURING INSTRUMENTS BEFORE STARTING

2.1 BATTERIES

The batteries are not installed in the new instruments they are delivered separately. It is recommended to remove the batteries when transporting the instruments.

2.1.1 INSERTING RESPECTIVELY REPLACEMENT OF BATTERIES IN BLUELEVEL

The status of the battery power is displayed e.g. **2, 7 Volt**

The lowest voltage is **1, 7 Volt**. After this limit has been reached a battery symbol blinking is displayed.

When the  symbol is blinking the batteries should be replaced.

2 pieces 1.5V, Size "C" ALKALINE

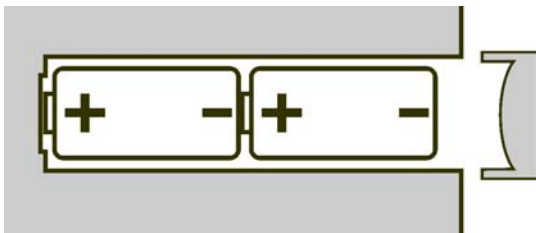

2.1.2 INSERTING RESPECTIVELY REPLACEMENT OF BATTERIES IN BLUEMETER SIGMA

2 pieces 1.5V, Size "C" ALKALINE

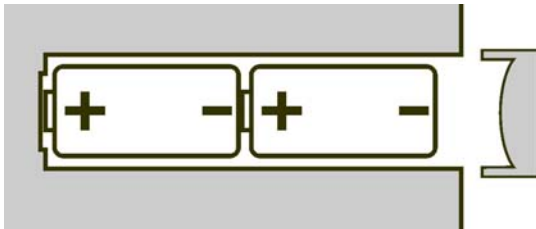

2.1.3 INSERTING RESPECTIVELY REPLACEMENT OF BATTERIES IN BLUETC

2 pieces 1.5V, Size "C" ALKALINE

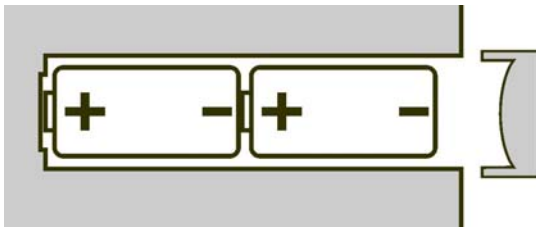

2.2 INITIAL STARTUP OF THE INSTRUMENTS

General remarks:

- The instruments belonging to a measuring group as described below in Pt. 2.4 is already done at WYLER's when the instruments are delivered.
- When a group of instruments are shut off e.g. after a measurement is completed, the group set-up remains saved. When started again, the communication is immediately ready, no additional set-up is required.
- When a group of instruments is extended e.g. by joining or replacing an instrument, this newly added instrument must be joined according Pt.2.4 „Combine a group....“

First time **start-up of a measuring group** (BlueLEVEL and BlueMETER SIGMA) **with radio transmission** (wireless transmission of the data):

1. Remove the instruments with care from the transport and storage case and insert the batteries
2. Place the instruments on a clean horizontally aligned surface and switch on the instruments (BlueLEVEL and BlueMETER SIGMA). Keep the two keys <ON/MODE> and <ZERO/SELECT ±> (BlueLEVEL), respectively the key <ON/MODE> (BlueMETER SIGMA) pressed until all 5 LED's are on. When the keys are released on the display is seen „SYSTEM TEST“. If the keys <ON/MODE> and <ZERO/SELECT ±> (BlueLEVEL), respectively the key <ON/MODE> (BlueMETER SIGMA) **are pressed longer than 10 seconds when STARTING the instrument** all the LED's are beginning to blink and the automatic shut-off system is deactivated. In the standard mode the instrument is automatically shut off after 60 minutes.
3. The instruments are now communicating and after a few seconds the measured values are displayed. The battery power should be checked (see below)
4. The measuring task may now be started.

First time start-up of a measuring group (BlueLEVEL and BlueMETER SIGMA) **without radio transmission** (transmission of the data by cables):

1. Remove the instruments with care from the transport and storage case and insert the batteries
2. Place the instruments on a clean horizontally aligned surface and connect the instruments with the cables supplied
3. Switch on the instruments. Keep the two keys <ON/MODE> and <ZERO/SELECT ±> (BlueLEVEL), respectively <ON/MODE> (BlueMETER SIGMA) pressed until all 5 LED's are on. When the keys are released on the display is seen „SYSTEM TEST“. If the keys <ON/MODE> and <ZERO/SELECT ±> (BlueLEVEL), respectively <ON/MODE> (BlueMETER SIGMA) **are pressed longer than 10 seconds when STARTING the instrument** all the LED's are beginning to blink and the automatic shut-off system is deactivated. In the standard mode the instrument is automatically shut off after 60 minutes.
4. The instruments are ready for use and the measured values are displayed. The battery power should be checked (see below)
5. The measuring task may now be started.

Remarks concerning the battery power:

BlueLEVEL

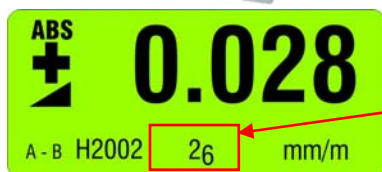

Display of the actual battery power (Example: 2,6 V)

The lowest voltage is **1,7 Volt**. After this limit has been reached a battery symbol blinking is displayed. The batteries should now be replaced in due time.

BlueMETER SIGMA

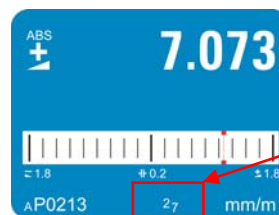

Display of the actual battery power (Example: 2,7 V)

The lowest voltage is **1,7 Volt**. After this limit has been reached a battery symbol blinking is displayed. The batteries should now be replaced in due time.

2.3 CONNECTING THE INSTRUMENTS

2.3.1 CONNECTING THE BLUEMETER SIGMA



CONNECTOR „A“



CONNECTOR „B“

- CABLE CONNECTION FOR INSTRUMENT BLUELEVEL OR WYBUS COMPATIBLE INSTRUMENT
- CABLE CONNECTION FOR EXTERNAL POWER SUPPLY
- CONNECTION TO PC OR LAPTOP
- CABLE CONNECTION FOR EXTERNAL POWER SUPPLY
- CABLE CONNECTION FOR INSTRUMENT BLUELEVEL OR WYBUS COMPATIBLE INSTRUMENT
- CABLE CONNECTION FOR EXTERNAL POWER SUPPLY

REMARKS:

AN EXTERNAL POWER SUPPLY UNIT MAY BE CONNECTED TO ANY FREE CONNECTOR

2.3.2 CONNECTING THE BLUETC

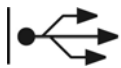
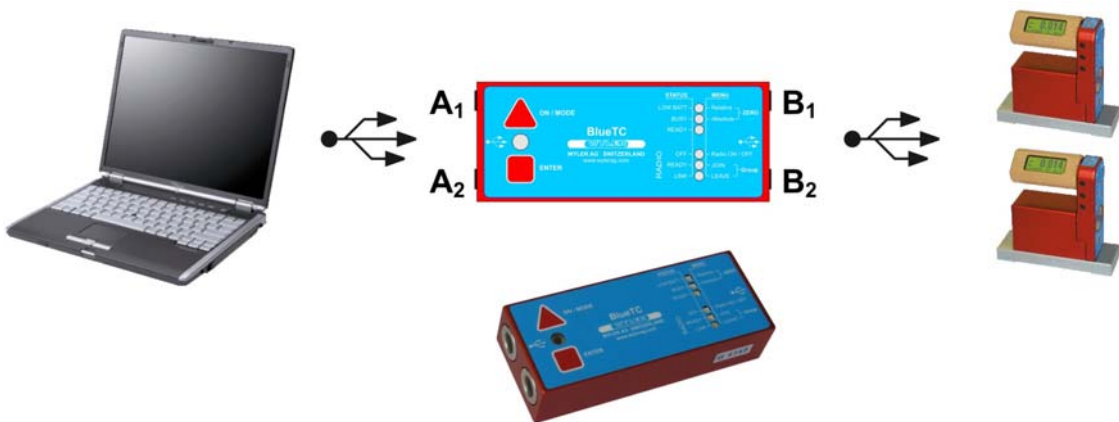

A₁
A₂

- CONNECTION TO PC OR LAPTOP
- CABLE CONNECTION FOR EXTERNAL POWER SUPPLY

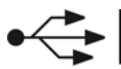

B₁
B₂

- CABLE CONNECTION FOR INSTRUMENT BLUELEVEL OR WYBUS COMPATIBLE INSTRUMENT
- CABLE CONNECTION FOR EXTERNAL POWER SUPPLY

REMARKS:

AN EXTERNAL POWER SUPPLY UNIT MAY BE CONNECTED TO ANY FREE CONNECTOR

2.4 COMBINE A GROUP OF INSTRUMENTS USING THE FUNCTION "JOIN"

The function "JOIN" enables the grouping of instruments. The grouping prevents the accidental reading of measuring values from instruments of another measuring group. The function "JOIN" can be performed using the cable connection or with wireless data transmission.

The function "JOIN" joins all the instruments connected to a group. Previously used groupings are cancelled.

For the function "JOIN" in wireless mode only one instrument can be added to the group at a time. No instruments must be connected by cables at the same time.

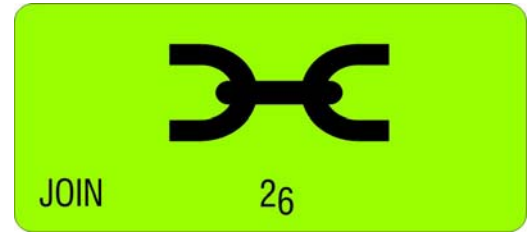

2.4.1 PROCEDURE "JOIN" WITH CABLE-CONNECTION

1. Connect all instruments (BlueLEVEL and BlueMETER SIGMA) to be joined to a group with the cables provided and switch on all the instruments
2. Select on the BlueMETER SIGMA the menu "JOIN" using the <ON/MODE> key. Confirm with the <ENTER> key. All instruments connected are now searched and joined to a group.
3. After establishing the group a "REFRESH" will be performed.
4. After the grouping the command "SENSOR" will be performed. As the measuring mode is still to be defined, the message "not-defined" will be displayed
5. The measuring mode ("A", "B" or "A-B" must now be selected. Select the mode preferred using the <ZERO/SELECT> keys (corresponding to the menu [SENSOR]) and confirm with <ENTER>

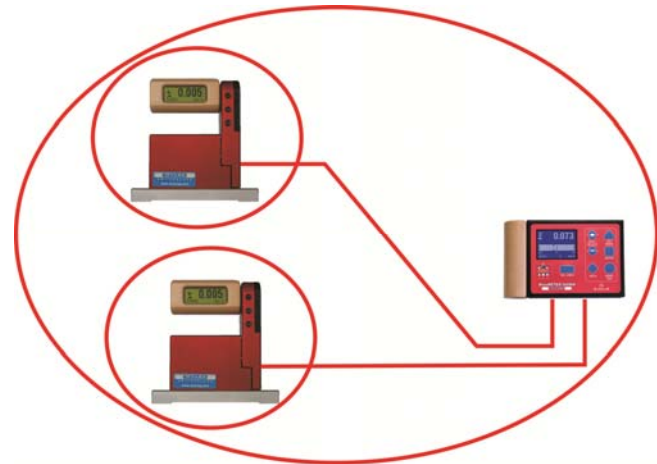

It is also possible to execute any other function of the menu. For instance it is possible to integrate with further "JOIN" commands additional instruments with wireless connection into the group

6. The sensors must be selected. Select the sensors for A and - depending on the measuring mode - also for B using the <ZERO/SELECT> keys and confirm with <ENTER>. The measuring values are now shown in the display according to the selected configuration.
7. After a successful grouping on both instruments the green LED "READY" will blink shortly as many times as instruments are joined in the measuring group (including the own address)
8. For using the wireless mode (the wireless mode must be switched-on on each instrument) the cables can now be removed. After removing the cables the measuring values will be "freezed" for a short while and replaced by empty zeroes until, after successful connection, the measuring values will be displayed again

Remark: After successful connection the blue LED "LINK" will be lighting on all the instruments connected.

2.4.2 PROCEDURE "JOIN" WITH WIRELESS DATA TRANSMISSION

With the function "JOIN" an instrument can be added by wireless data transmission to an existing group. During this procedure no instrument must be connected by cables as otherwise the "JOIN" procedure for cables will be performed.

IMPORTANT:

Only two instruments can be grouped in one procedure. If more instruments are members of a measuring group, e.g. a BlueLEVEL "1", a BlueLEVEL "2" and a BlueMETER SIGMA it is recommended to group first the BlueLEVEL "1" with the BlueMETER SIGMA and then the BlueLEVEL "2" also with the BlueMETER SIGMA. The affiliation to the measuring group will be communicated between the members.

The **two instruments to be grouped** must be set to the **JOIN-mode**. The **<ON/MODE>** key must be pressed repeatedly until the mode **[JOIN]** appears in the display. Confirm with **<ENTER>**

Searching

1. Both instruments are "searching" each other. During the searching procedure the green LED on both instruments are lit continuously. The instruments remain in the "search" mode until they have detected each other.

During the search process the following picture will be displayed:

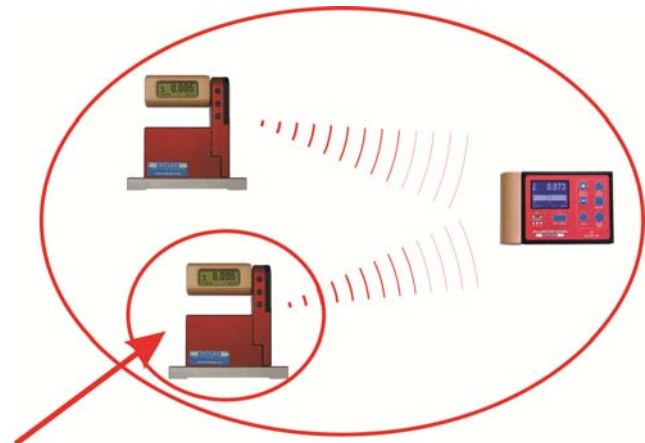

Remark: The searching process may go on for several minutes in bad communication conditions.

2. Group connection

As soon as the two instruments have successfully detected each other the search process is stopped and this is visualised by a rapid blinking (4 to 5 times per second) of the green LED's on both instruments.. The joining can no be activated by

- using the **<ENTER>** key on one of the instruments

or

- the whole process may be cancelled by pressing the **<ON/MODE>** or the **<SEND/ESC>** key.

3. After establishing the group a **"REFRESH"** will be performed.
4. After the grouping the command **"SENSOR"** will be performed. As the measuring mode has been cancelled during the JOIN procedure this mode must be selected again. The message **"not-defined"** will be displayed
5. The measuring mode ("A", "B" or "A-B" must now be selected. Select the mode preferred using the **<ZERO/SELECT>** keys (corresponding to the menu **[SENSOR]**) and confirm with **<ENTER>**

It is also possible to execute any other function of the menu. For instance it is possible to integrate with further "JOIN" commands additional instruments with wireless connection into the group

6. The sensors must be selected. Select the sensors for A and - depending on the measuring mode - also for B using the **<ZERO/SELECT>** keys and confirm with **<ENTER>**. The measuring values are now shown in the display according to the selected configuration.
7. After a successful grouping on both instruments the blue LED "LINK" will be lit continuously. The green LED "READY" will blink shortly as many times as instruments are joined in the measuring group (including the own address)

Attention: If the LED "OFF" is blinking in red, a connection is not possible (see chapter 2.4.2 / special case)

2.4.3 SPECIAL CASES “JOIN”

In case both instruments are already joined in different groups of instruments they do find each other but they can not communicate together. The red LED “OFF” is blinking. The search process may be cancelled by using the key <ON/MODE> or <ENTER>

If it is required to use one of the instruments in the new measurement group it is necessary to use the mode “LEAVE” to cancel the existing connection.

2.5 UNHINGE AN INSTRUMENT IN THE RADIO MODE FROM A GROUP BY USING THE FUNCTION „LEAVE“

Each instrument may be unhinged from an existing group of connected instruments.

PROCEDURE „LEAVE“

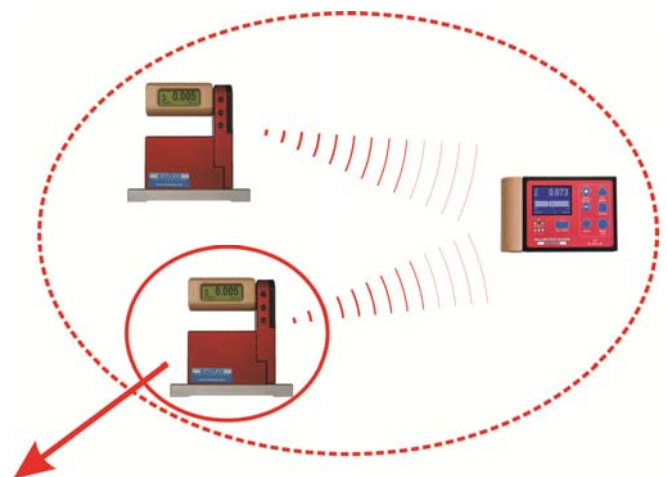

1. If BlueLEVEL instruments are transmitting measuring values to a BlueMETER SIGMA or a BlueTC, the keys on the BlueLEVELs are locked. To unlock a BlueLEVEL, the settings at the BlueMETER SIGMA have to be changed in such a way it no longer communicates with this BlueLEVEL.
2. The instruments to be disconnected must be set to the mode LEAVE. The <ON/MODE> key must repeatedly be pressed until in the display shows the mode [LEAVE]. Confirm with <ENTER>
3. During the leaving mode the blue LED is blinking under “LINK”, the green LED “READY” is not blinking respectively off.
4. After the successful procedure the green LED is blinking once for approx. 1 second. With this the unhook process is finished.

2.6 RENEWED CONNECTION OF A MEASURING GROUP

After a measuring group has been stopped e.g. after the termination of a measurement, the group of instruments remains intact. After the restart the communication is automatically activated and the communication is started. The process JOIN must not be repeated.

3 DESCRIPTION OF THE KEYS AND FUNCTION OF THE BLUELEVEL WITH AND WITHOUT RADIO TRANSMISSION

Starting the BlueLEVEL

Press the <ON/MODE> and <ZERO/SELECT ±> keys located opposite on the handle until all the LED's on top of the handle are illuminated and on the display "SYSTEM CHECK" is shown before the actual display appears.



3.1 THE BLUELEVEL

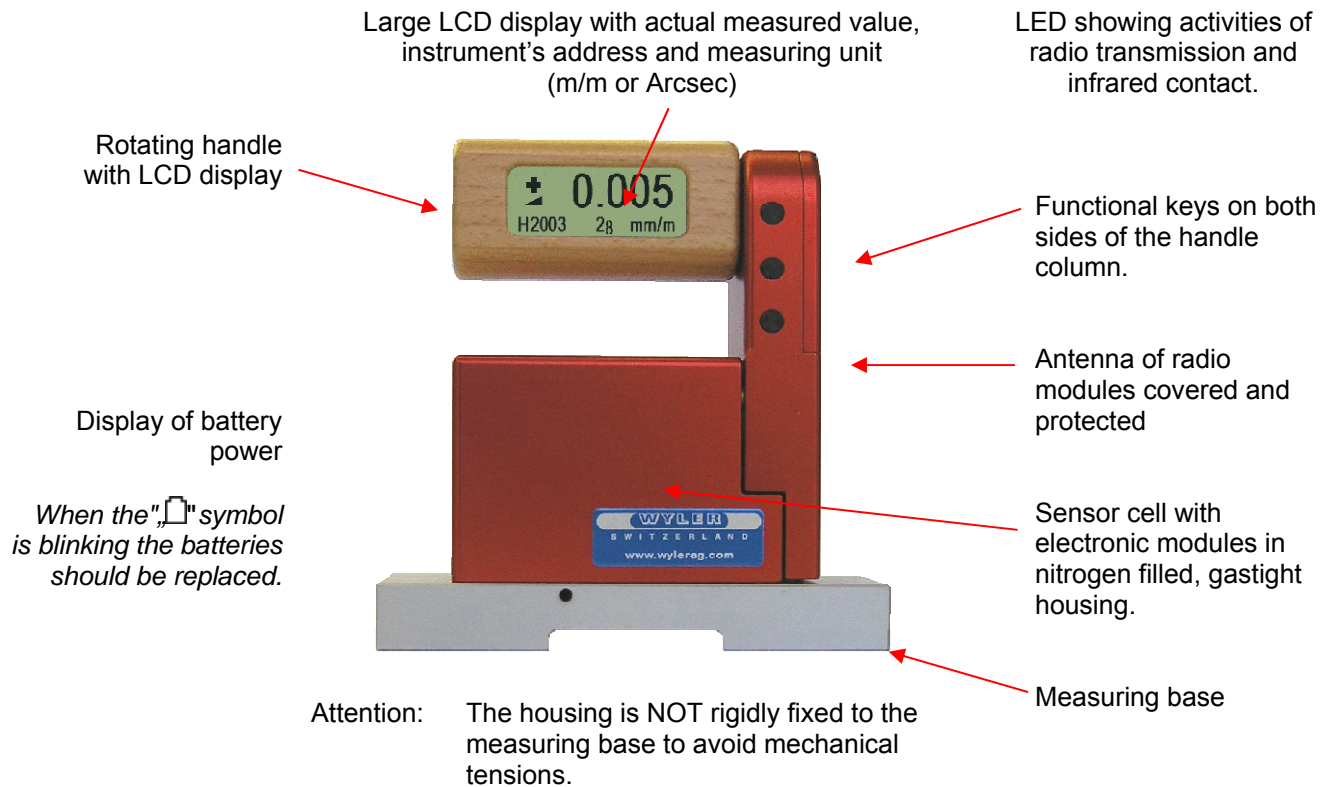

Attention: The housing is NOT rigidly fixed to the measuring base to avoid mechanical tensions.

3.2 VIEW OF FUNCTIONAL KEYS BLUELEVEL

3.2.1 REAR VIEW

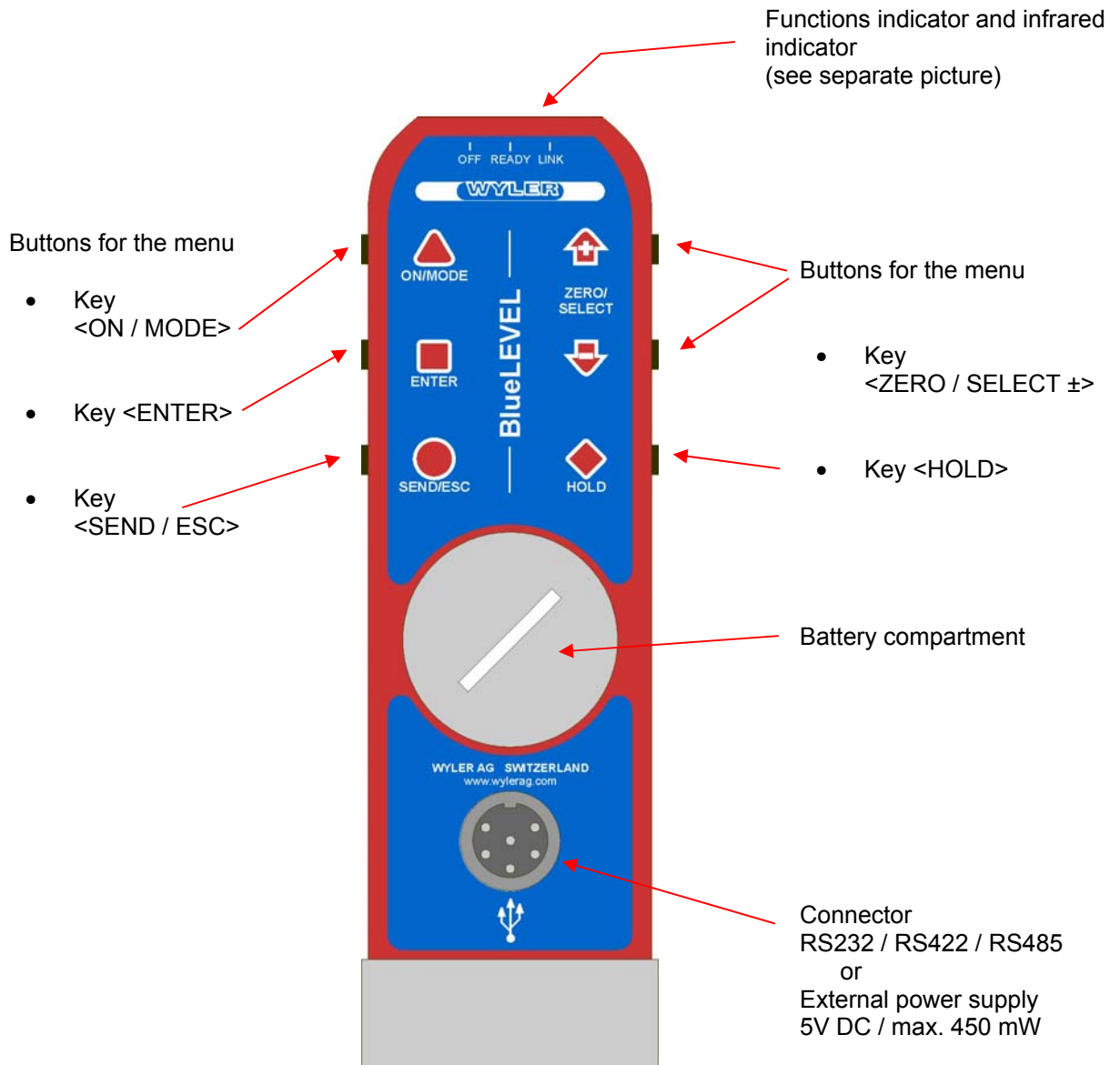

3.2.2 TOP VIEW

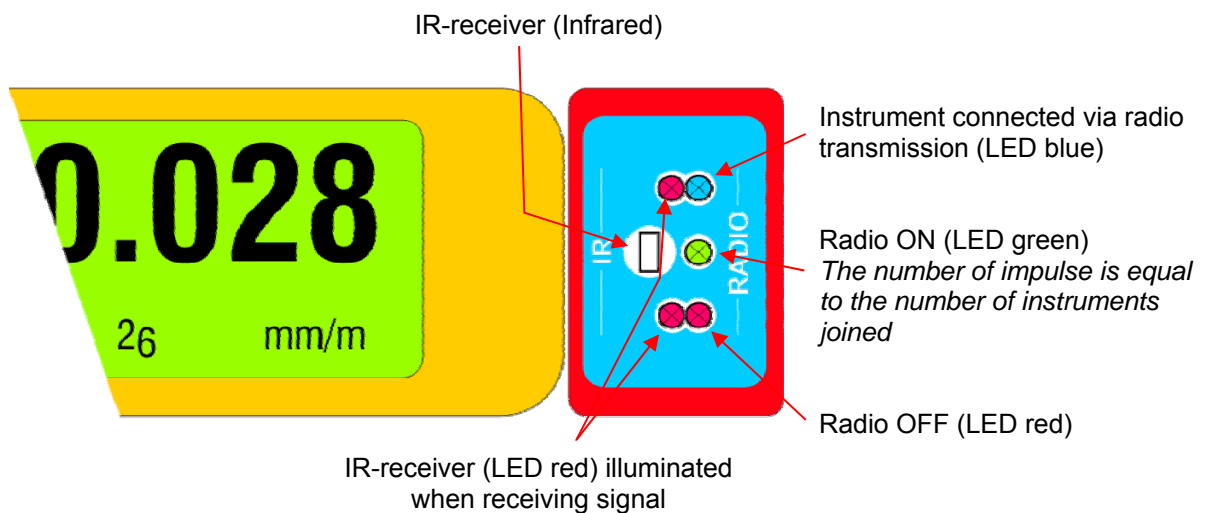

3.3 FUNCTIONAL MENU WITH BLUELEVEL USING THE FUNCTION KEY

(same applies partially for BlueMETER SIGMA and BlueTC) / according to G. Lasczyk
 ... using the key <ON/MODE>

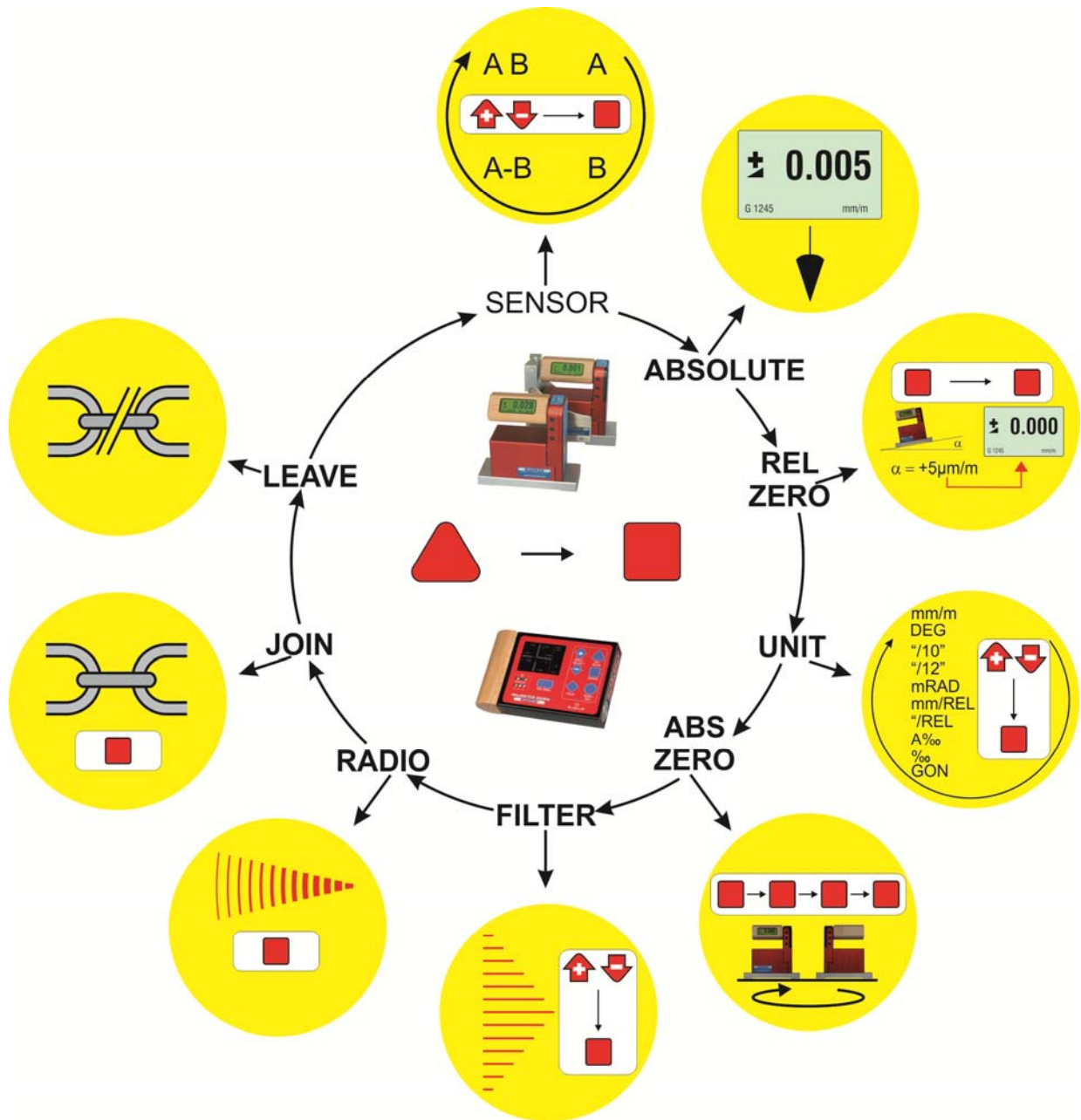

FOR ADDITIONAL DETAILS PLEASE CONSULT THE FLOW CHARTS CHAPTER "L / [FLOWCHARTS](#)" PAGES 86.....97

<p>Switching the instruments ON</p>
<p>SENSOR (BlueMETER SIGMA only)</p>

- Starting the **BlueLEVEL**. Press the <ON/MODE> and <ZERO/SELECT ±> keys located opposite on the handle until all the LED's on top of the handle are illuminated and "**SYSTEM CHECK**" is shown on the display. After starting the actual measured value as well as the last used unit is displayed.
- Starting the **BlueMETER SIGMA**. Press the <ON/MODE> key until all the LED's are illuminated and "**SYSTEM CHECK**" is shown on the display. After starting the actual measured value as well as the last used unit and configuration is displayed.
- Setting the active sensors/ports and selection of the single ore differential measurement display **BlueMETER SIGMA only**.

ABSOLUTE	Standard measuring mode, absolute measured value (Zero-offset considered) The instrument displays the actual deviation from a horizontal plane.
-----------------	---

REL ZERO	Relative measured value (In the relative mode a „ZERO-OFFSET“ determined e.g. by reversal measurement is superimposed by the value „REL ZERO OFFSET“)
-----------------	---

Option 1 / Automatic setup

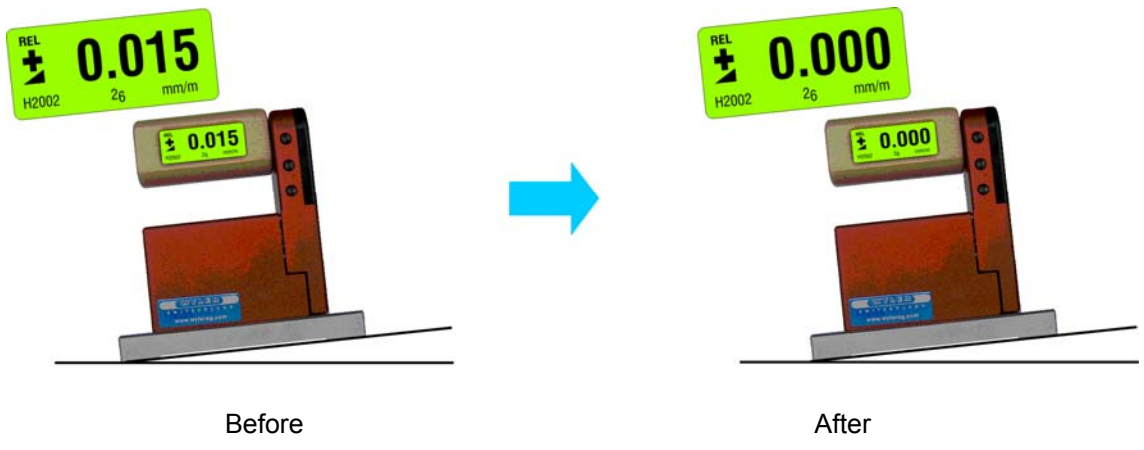

Use the key <ON/MODE> select [REL.ZERO] and confirm with <ENTER>. First the following picture is shown in the display

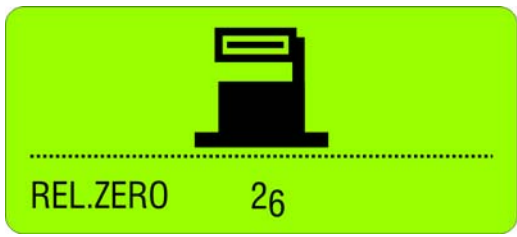

Using <ENTER> or the IR-zapper for confirming the choice. The actual values are collected and constantly displayed.

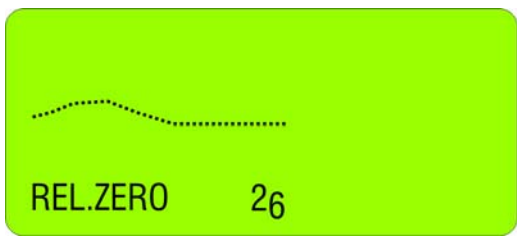

When the values have stabilized the relative ZERO can be confirmed with <ENTER> or with the IR-zapper.



On the display the value "0.000" is seen. This is now the relative value considering the offset. This value is used for all additional measurements as reference.

**Cont.
REL ZERO**

Option 2 / Manual setup

Use the key **<ON/MODE>** select **[REL.ZERO]** and confirm with **<ENTER>**. First the following picture is shown in the display

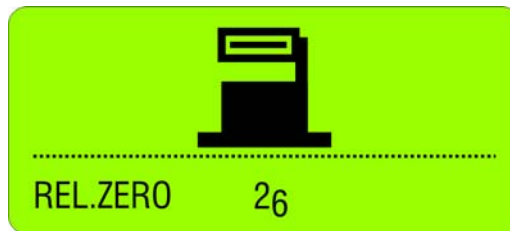

Use **<ON/MODE>** for cancelling the procedure

The following picture is seen. It shows an earlier value for a **ZERO OFFSET**.

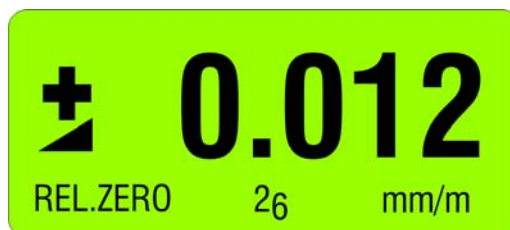

This value may now be changed manually with the key **<ZERO/SELECT ±>** and then confirmed with **<ENTER>**.

On the display the value is seen. This is now the relative value considering the offset. This value is used for all additional measurements as reference. E.g.



UNIT

Selection of unit (**[mm/m]**, **[Arcsec]** or **[mm/REL]**)

Using the key **<ON/MODE>** select the menu **[UNIT]** and confirm with **<ENTER>**. Using the keys **<ZERO/SELECT ±>** select the required unit and confirm with **<ENTER>**.

ABS. ZERO

Setting of absolute ZERO with a **reversal measurement**.

Using the reversal measurement is a simple way to determine the exact **ZERO OFFSET** of the instrument as well as the exact inclination of the surface the instrument is placed on.

- Slide the instrument onto a flat, horizontally levelled surface (e.g. engineer's surface plate).
- The position of the instrument is to be marked on the surface.
- Use the key **<ON/MODE>** to get to the menu point **[ABS.ZERO]** and confirm with **<ENTER>**

The following display is seen:

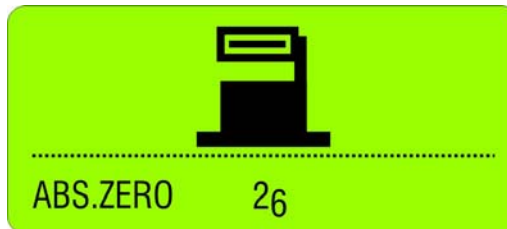

- Use the zapper or confirm with **<ENTER>**. On the display the progress of the collected values are visible in graphic form.

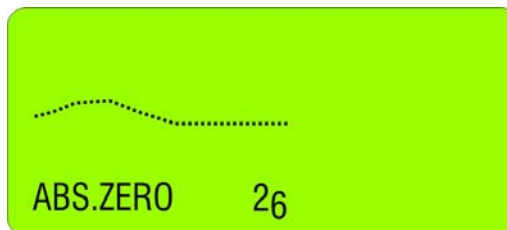

When the curve is getting a straight line confirm the first value with the zapper or with **<ENTER>**

- After the first reading the following display is seen:

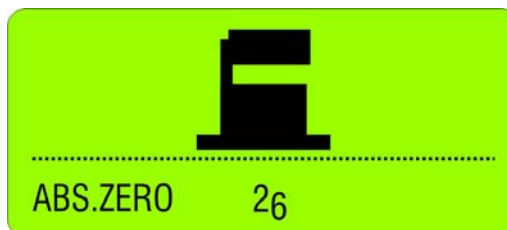

This display means the first reading was successful. The instrument must be turned 180 degrees without lifting it and slid exactly onto the previously marked position

- Use the zapper or confirm with **<ENTER>**. On the display the progress of the collected values are again visible in graphic form.

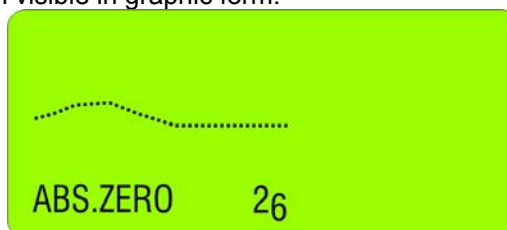

**Cont.
ABS.ZERO**

- When the curve is getting a straight line confirm again the second value with the zapper or with **<ENTER>**

After the second reading the following display is seen:



With this the reversal measurement is finished and the instrument shows the true absolute value.

FILTER

Setting a filter type

Using the key **<ON/MODE>** select the menu [FILTER] and confirm with **<ENTER>**. With the key **<ZERO/SELECT ±>** choose the filter type and confirm with **<ENTER>**.

RADIO

Switch radio mode ON or OFF (using cable transmission)

Use the key **<ON/MODE>** select the menu [RADIO] and confirm with **<ENTER>**.

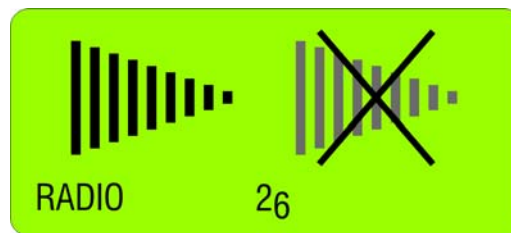

For definitely switching On or Off confirm again with **<ENTER>**. After switching the radio OFF the **red LED on the handle is on**.

Returning to the radio mode follow the same procedure. When the radio mode is on, the **green LED on the handle is on**.

JOIN

Combine a group of instruments to a measurement group

See detailed description in chapter 2.4:

Combine a group of instruments to a measurement group using the function "JOIN" In radio transmission mode

LEAVE

Unhinge an instrument in the radio mode from a group

See detailed description in chapter 2.5

Unhinge an instrument in the radio mode from a group by using the function "LEAVE"

**FOR ADDITIONAL DETAILS PLEASE CONSULT THE
FLOW CHARTS CHAPTER "L / FLOWCHARTS" PAGES 86.....97**

ADDITIONAL FUNCTIONS

Function KEY-LOCK / key lock and unlock by using the push buttons

Using the following function the keys may be locked or unlocked

KEY-LOCK <ON>

Keep the key <ENTER> pressed for a minimum of 2 seconds until in the display shows „LOCKED“

When the keys are locked the respective symbol is displayed as shown below



The KEY-LOCK function is meant to eliminate any unintended pressing of a key and starting an unplanned action, such as e.g. a <HOLD> function.

It is however possible to make all the required measurements without restrictions.

KEY-LOCK <OFF>

Keep the key <ESC> pressed for a minimum of 2 seconds until after a short display of the sign "LOCKED" in the display the above mentioned symbol disappears and "UNLOCKED" is shown.

3.4 TEACH-IN of the IR-trigger (Zapper)

In order to eliminate interference of the zapper signals when several measuring groups are active in the triggering range the IR trigger can be assigned to a specific measuring group by applying the function TEACH-IN

Procedure **TEACH-IN**:

- The measuring or display instrument must be started.
- Keep the key <ZERO/SELECT ±> on the measuring or display instrument pressed
- Point the trigger (IR Zapper) in the direction of the measuring or display instrument
- Press the **actuator key** on the IR Zapper until both red IR LEDs are lighting up.

This procedure must be done on all the measuring and display instruments using the same IR triggering. When the instruments are dispatched this procedure is already factory set standard.





3.5 OPERATING THE BLUELEVEL

3.5.1 DESCRIPTION OF THE VARIOUS KEYS

If the instrument is remotely controlled by a BlueMETER SIGMA the key functions are blocked with very few exceptions.

All functions have to be executed at the BlueMETER SIGMA.

 <ON/MODE> – key	
<p>Function - 1 –</p> 	<p>Starting the BlueLEVEL. Press the <ON/MODE> key until all the 5 LED's are illuminated and on the display "SYSTEM CHECK" is shown.</p> <p>After starting the actual measured value as well as the last used unit is displayed. e.g.:</p> <div style="text-align: center;">  </div> <p>Actual value and unit set actual leading sign and showing the measurement mode (in the example: ABS = ABSOLUTE mode)</p> <p>Unit in [mm/m], resp. [µm/m] or in [Arcsec]</p> <p>Serial number of instrument used as identification. In the example the reference instrument "B" is active. The mode is differential measurement „A-B“, the address of the instrument "B" is H2002 (Address shown beside "B")</p> <p>Actual battery power</p> <p>Deactivating the automatic instrument shut off of the BlueLEVEL: When pressing the <ON/MODE> and <ZERO/SELECT ±> keys at the starting of the instrument longer than 10 seconds all LED's start blinking and the automatic shut off is deactivated. Using the battery mode, the instrument is automatically shut off after 60 minutes. Exception: When the BlueLEVEL or the BlueMETER SIGMA is connected to an external power supply the instrument never shuts off automatically.</p>
<p>Function - 2 -</p>	<p>The key <ON/MODE> is used for handling the internal menu. When pressing several times other menu points are displayed.</p>
<p>Function - 3 -</p>	<p>For shutting off the BlueLEVEL the key <ON/MODE> must be pressed continuously until all 5 LED's are on and the instrument's display is completely off.</p> <p>When the key <ON/MODE> is continuously pressed for longer than 15 seconds, a date and a 4-digit number is displayed. This number shows the software version loaded in the instrument.</p>
<p>Function - 4 -</p>	<p>Setting the displayed values (memory values) of the functions "REL ZERO" and "ABS ZERO" to ZERO. When a value is displayed in this function the value can be set to ZERO by pressing the key <ON/MODE> or the value can be altered step by step by using the key <ZERO/SELECT ±>. The action must be confirmed by using <ENTER>.</p>



<ENTER> – Key

Function – 1 – The key <ENTER> is used for saving data or for confirming actions taken.

Function - 2 - In connection with the software LEVELSOFT and MT-SOFT the key is used for collecting the actual measured value.

It is not recommended to use this key due to unsettle the instrument when the key is pressed. It is recommended to use the infrared zapper or the <ENTER> key on the BlueMETER SIGMA instead.



<SEND/ESC>- Key

Function – 1 – Using the key <SEND/ESC> will send the displayed value to a port of a connected PC, or Laptop. It is not recommended to use this key due to unsettle the instrument when the key is pressed. It is recommended to use the infrared zapper or the <SEND/ESC> key on the BlueMETER SIGMA instead.

OUT-port data format

MeasuringMode_A	[sss xxxxxx sn.nnnnnn<cr>]
MeasuringMode_B	[sss xxxxxx sn.nnnnnn<cr>]
MeasuringMode_A_minusB	[sss xxxxxx - xxxxxx sn.nnnnnn<cr>]
MeasuringMode_A_B	[sss xxxxxx sn.nnnnnn xxxxxx sn.nnnnnn<cr>]

sss = 0 .. 255 - Sequence number

xxxxxx = **Sensor Serial Number and Type**

H4001B	BlueLEVEL
H4001C	+CLINO PLUS+
H4001M	MINILEVEL NT
H4001Z	ZEROTRONIC Sensor
H4001x	ZEROMATIC 2/1 X-Axis
H4001y	ZEROMATIC 2/1 Y-Axis
H4001X	ZEROMATIC 2/2 X-Axis
H4001Y	ZEROMATIC 2/2 Y-Axis

sn.nnnnnn =	+9.999999 - Positive Overrange
	-9.999999 - Negative Overrange
	Measured value - Angle in rad e.g. +0.226349

Data transmission format:

asynchron, 7Bit, 2 Stopbits, no parity, 9600 Baud

Function - 2 - Delete the "<HOLD>" function and return to the mode **MEASURE**.

Function - 3 - **Cancel** the functions of the various menus



ZERO/SELECT "+/-" - Keys

Function - 1 -

The keys **ZERO/SELECT "+/-"** are used for selecting different settings, such as:

- Measuring unit
- Ports ("A" / "B" / "A - B" / "A B") / only **BlueMETER SIGMA**
- Relative base settings
- Set "**Zero-Offset**"
- Set "**REL Zero-Offset**" etc.

Function - 2 -

In the operating mode "A B" the values of both instruments connected to the ports "A" and "B" are displayed on the **BlueMETER SIGMA** simultaneously one above the other.

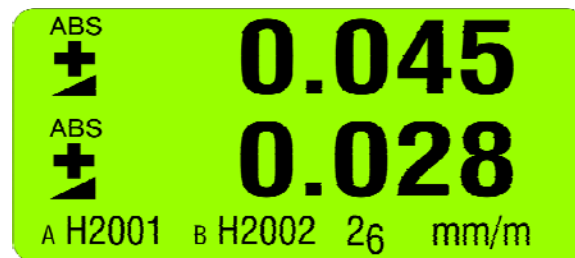

Upper display:
Measuring instrument port "A"

Lower display
reference instrument port "B"



<HOLD> - Key

Function - 1 -

With the **<HOLD>** key a measured value may "frozen". After pressing the key **<HOLD>** without further action by the user, the measured value is collected during 25 seconds and then displayed. When the conditions are stable this data collection may be reduced by earlier pressing the key **<ENTER>**. The display shows "on hold". This "frozen" value will be displayed until by pressing the key **<SEND/ESC>** the BlueLEVEL will return to the measuring mode. If in the "on hold" mode a BlueMETER SIGMA takes over the control the instrument automatically returns to the measuring mode

Function - 2 -

When using the mode **REL ZERO** and **ZERO** the actual measuring value can be accepted by pressing the **<HOLD>** key.



Mirroring the display

With the two middle keys <ENTER> and ZERO/SELECT the display can be mirrored diagonally. With this function in combination with the rotary handle bar the values displayed can be perfectly seen from all possible angles. This function can be executed at all times, even when the instrument is remotely controlled by a BlueMETER SIGMA.



Left:
Display "standard"



Right:
Display mirrored diagonally

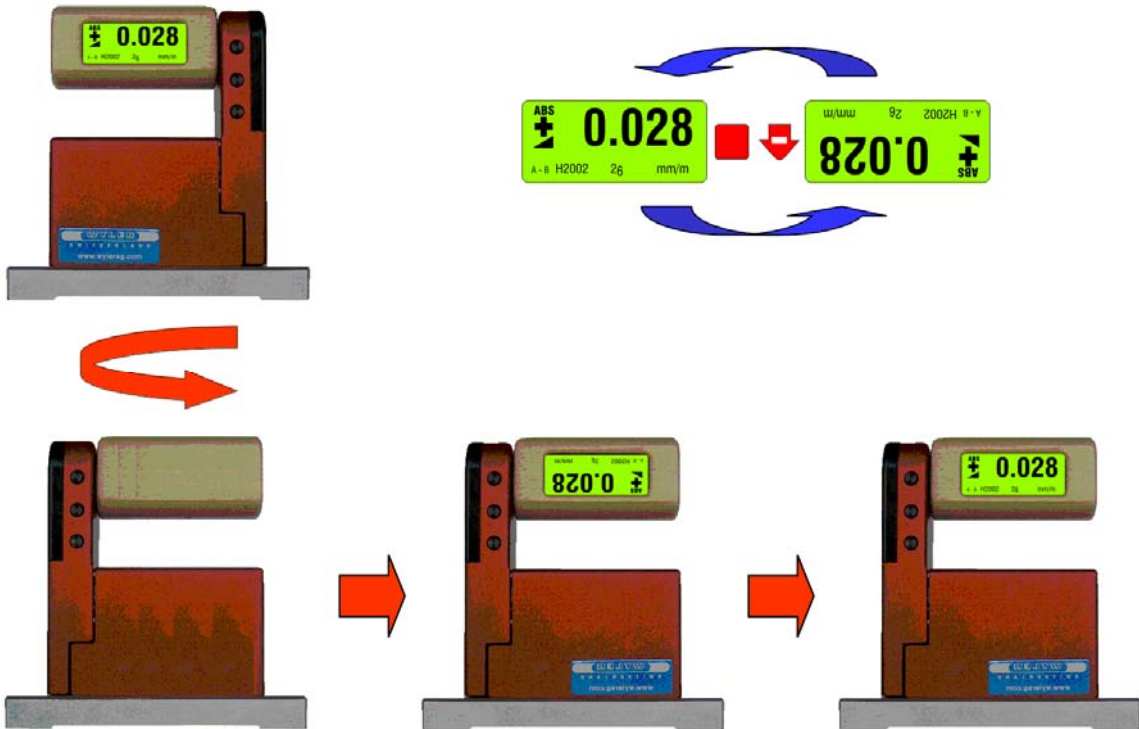

3.5.2 DESCRIPTION OF VARIOUS DISPLAY FORMS ON THE BLUELEVEL



Display of the actual measured value



Display in [mm/m]
The instrument is as single unit in a group active

Port "A": Address of the instrument:
H2080



Display in [mm/m]
The instrument is as reference unit in a group active

Port "B": Address of the instrument:
H2002. The address of the second
instrument "A" is only shown on the
BlueMETER SIGMA.



The picture shows the direction of the value's inclination



Inclined to the right: positive

Declined to the right: negative

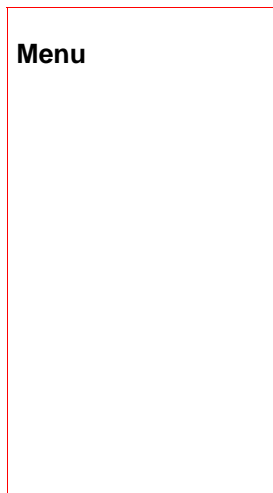

ABSOLUTE	Standard measuring mode
REL ZERO	Relative measurement
UNIT	Setting the required units
ABS.ZERO	Setting absolute zero
FILTER	Setting a filter type
RADIO	Switch radio mode ON or OFF
JOIN	Joining a group of instruments
LEAVE	Leaving a group of instruments

Status of battery power "BATT"

Usually the actual battery power is displayed, e.g. 26 (2.6 Volt)

Regarding the status indication of the internal power the following options are possible:

Note: The internal voltage U_{INT} must not be confused with the Battery voltage U_{BATT} respectively the external supply voltage U_{EXT} !

External Power Supply U_{EXT}

Battery supply U_{BATT}

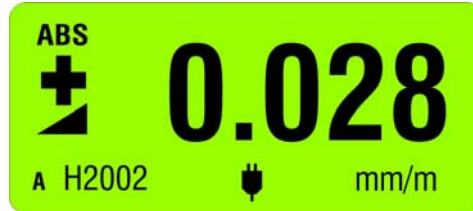

Indication with sufficient voltage $U_{INT} > 4,75V$



Indication with sufficient voltage $U_{INT} > 4,75V$



Supply voltage $U_{INT} < 4.75V$



Supply voltage $U_{INT} < 4.75V$

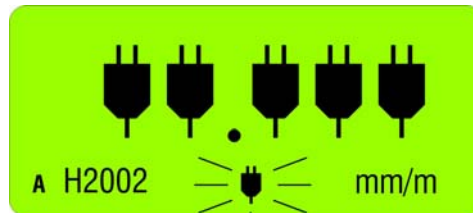

Supply voltage $U_{INT} < 4.5V$
Measuring no longer possible

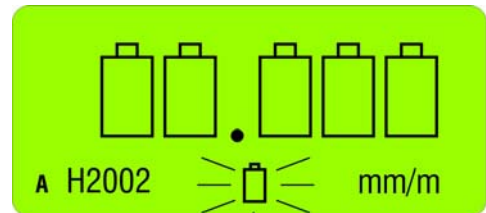

Supply voltage $U_{INT} < 4.5V$
Measuring no longer possible

Measuring unit

Display of the actual unit set.
2 basic units are available in the BlueLEVEL [mm/m] and [Arcsec]

Sensor-Address

- Function – 1** Display of active port address
 - of the instrument showing the measured value
 - connected instrument/sensor used for calibration

- Function - 2** Display of the measuring mode, e.g. individual instrument or differential measurement (Sensor A - Sensor B)

Note:

If this symbol appears in the display, this means that the instrument is performing any function.

During this time the measuring instruments should not be touched and the process should not be cancelled.

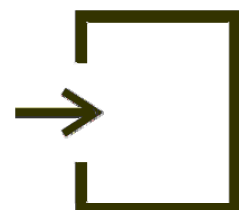

4 BASICS / INTRODUCTION

The new **BlueMETER SIGMA** has been developed as a successor respectively replacement of the two display units LEVELMETER 2000 and BlueMETER. With the BlueMETER SIGMA the measuring data can be transmitted via cable or wireless to a PC/Laptop.

The BlueMETER SIGMA is compatible with WyBus. Therefore a wide range of measuring instruments and sensors can be read, such as

- the measuring instruments of the BlueSYSTEM family
- ZEROTRONIC sensors
- ZEROMATIC 2/1 and 2/2
- MINILEVEL NT
- LEVELTRONIC NT



The BlueMETER SIGMA serves as

- a display unit
- an interface between instruments and PC/Laptop

On the BlueMETER SIGMA various parameters, such as

- measuring unit
- measuring mode
- relative base length etc.

can be changed or adjusted.

Additional functions and features of the BlueMETER Sigma:

- New design with aluminum housing and latest technology
- Optional wireless communication based on Bluetooth® technology: a single worldwide standard
- Display of measuring values in various measuring units, such as
 - $\mu\text{m}/\text{m}$ or mm/m to three decimal places
 - inches/10 inches
 - Milliradian
 - degrees/Arcmin/Arcsec
 - $\text{mm}/\text{relative base length}$
 - etc.
- Powered by standard 1.5 V batteries type C
- CE compatible

4.1 START-UP OF THE BLUEMETER SIGMA BEFORE YOU START

Read this manual carefully before working for the first time with the BlueMETER SIGMA. You will get an overview on the versatile functions and possibilities offered by this display unit. At the same time you get familiar with the various operating elements. Thus you can avoid faulty manipulations.

4.1.1 PREPARATION AND START-UP OF THE BLUEMETER SIGMA

4.1.1.1 OVERVIEW KEYBOARD AND DISPLAY

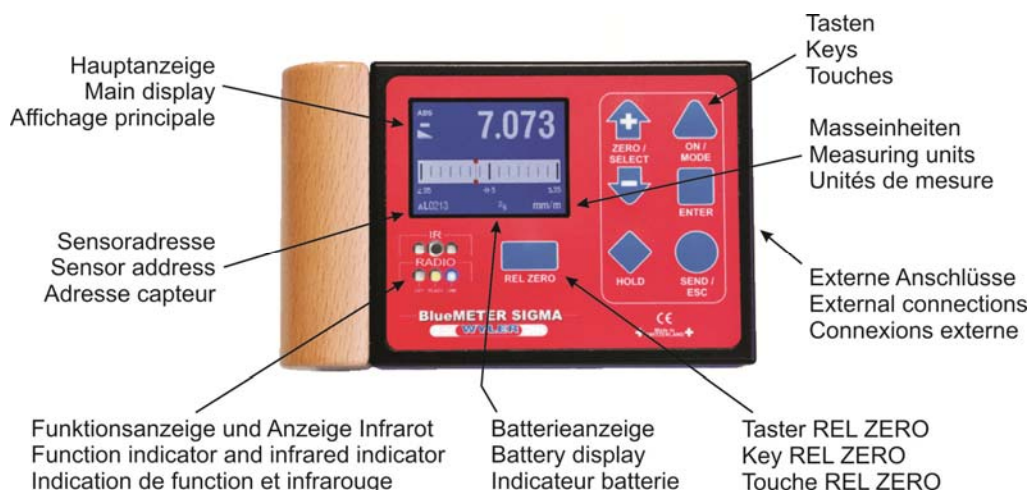



Colour display

<ZOOM OUT>
or
<previous option>

<ZOOM IN>
or
<next option>

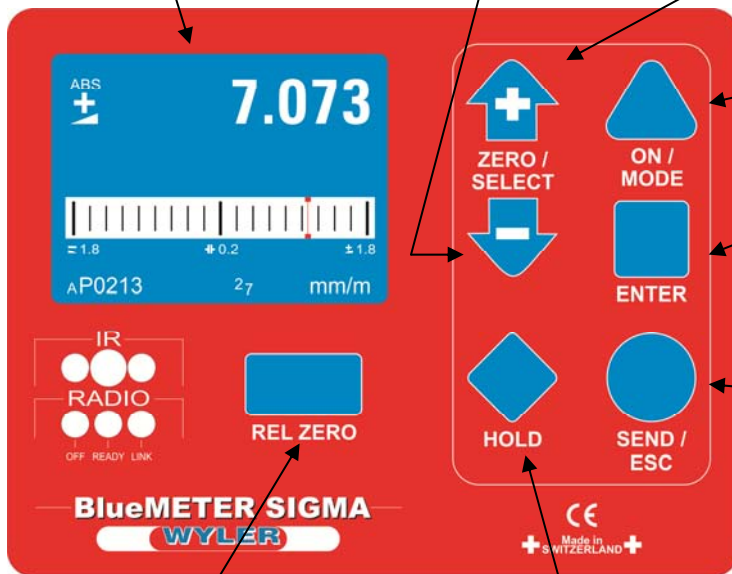

<ON/OFF>
or
<select menu>

<accept selection>
or
<save entry>

<to print measuring value>
or
<unfreeze and print / transmit
HOLD - inclination value>
or
<escape from the menu>



To use current inclination as
<relative Zero>



<Freeze>

4.1.1.2 SWITCHING THE INSTRUMENT ON AND OFF

The BlueMETER SIGMA features an automatic shut off. In normal mode the instrument is automatically switched off 60 minutes after the last key operation. This automatic shut OFF function can be deactivated with a special ON sequence or when using an external power supply

To switch the instrument ON

Keep the key   pressed until the display and all LEDs are lit and release the key. The instrument will automatically shut off 60 minutes after the last key operation.

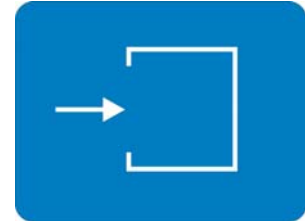

If you keep the key   pressed for **more than 10 seconds** the automatic OFF function is deactivated. This is indicated by blinking LEDs.

The instrument carries out a short function test and establishes connections to other instruments, if any had been available before switching off the instrument.



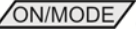

The instrument changes into measuring mode. The settings, which were used prior to switching the instrument off, are reloaded.

To switch the instrument OFF

Keep the key   pressed until the display disappears (about 3 seconds). All settings are kept and will be reloaded again next time the instrument is switched on.

4.1.2 KEYS / FUNCTIONS / SHORT DESCRIPTIONS OF EACH SINGLE KEY

	ON/MODE - key
---	----------------------

Function - 1 - Serves to switch the BlueMETER SIGMA ON. When for starting the key  is pressed, a grey picture will appear on the screen and all LEDs will be illuminated. After releasing the key the BlueMETER SIGMA is switching to the measuring mode. The current inclination of the measuring instrument is displayed in the mode and unit which was used before switching the instrument OFF. In case of an error the respective error message is shown in the display. The instrument will automatically shut of 60 minutes after the last key operation.

If the key  is pressed **for more than 10 seconds** the LEDs start blinking and the **automatic OFF function is deactivated**.

Exception: If the BlueMETER SIGMA is powered from an external power supply, the automatic OFF function is deactivated and the instrument will remain ON.

Function - 2 - To switch the instrument OFF, press the key  **more than 3 seconds**, until the display disappears.

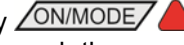
Function - 3 - With the key  you open the menu. Pressing the key repeatedly will move you through the menu which is indicated by the cursor moving down to the required function.

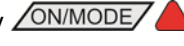
Function - 4 - While manually setting a value with the key  the default value can be recalled.

	ENTER – key
---	--------------------

Function - 1 - The key  is used to confirm a chosen function or to save a value entered.

Function - 2 - While in the function "REL ZERO" or "ABS ZERO" the measuring can be started or an ongoing measuring can be finished by pressing the key .



SEND/ESC- key

Function - 1 - The key is used to send / transmit a measuring value to a PC or to a printer or similar output device through the RS485 port

Data format OUT port:

[sss xxxxxx sn.nnnnnn<cr>]

sss = 0 ... 255 – Continuous number

x xxxxxx = Sensor Serial Number and Type
(example: N2673L BlueCLINO)

sn.nn sn.nnnnnn = inclination in rad, e.g. +0.226349
+9.999999 -> Positive Overrange
-9.999999 -> Negative Overrange

Format of transmission:

asynchron, 7Bit, 2 Stopbits, no parity, 9600 Baud

Function - 2 - Unfreeze of the "HOLD"-function to return to the measuring mode. At the same time the "frozen" value is sent to the RS 485 port to any connected device

Function - 3 - **Escape** from an entry function or from the menu



ZERO/SELECT "+/-" - keys

Function - 1 - The keys are used to

- changing the scale in the display
- increase / decrease the display range

This function can, however, be disabled in the instrument settings.

Function - 2 - The keys are used to select possible adjustments, such as

- menu selection
- modification of a figure in the menu



HOLD - key

Function - 1 - The key serves for "freezing" a measuring value. The value is displayed until the BlueMETER SIGMA returns to the measuring mode by pressing the key.

Function - 2 - In the functions "REL.ZERO" and "ABS.ZERO" the key is used for reading in the actual measuring value again during the manual entering.



REL ZERO - key



Function - 1 - The key serves for setting the actual inclination as the relative Zero.

4.2 DISPLAY

The BlueMETER SIGMA features various graphic displays which can be scaled according to the requirements of the measuring task. Also the background colour and the brightness of the display can be adjusted.







4.2.1 SCALING OF THE DISPLAY





For an optimal use of the graphic display, you have various options for scaling.

With the linear scaling the display precision remains constant over the full range. With the keys    the resolution can be changed. Thus also the range being displayed will be changed. The following ranges can be selected, whereas certain restrictions may be possible depending on the display type and the measuring unit selected: 60°, 45°, 20°, 10°, 5°, 2°, 1°, 30', 12', 5', 2', 1', 30", 15".

With the logarithmic scaling the display precision around Zero is the highest and it is reduced continuously with higher inclination values. Around Zero the resolution corresponds to the unit selected.

In the adjustments of the instrument you can switch between linear and logarithmic scaling.

Using the key   select the menu point [Options] and confirm with  . Select now [Logscale] and confirm with  .

Switch the logarithmic scaling ON or OFF using the keys   . The display will show the requested state of the instrument. Confirm with the key  .







The instrument will return to the measuring mode. If the logarithmic scaling is enabled, the symbol "LOG" will appear below the graph.

4.4.2 DISPLAY TYPES

The display type can be selected in the menu "display".

Using the key   select the menu point [Display] and confirm this selection with  .

Select the required display type using the keys    and confirm your selection with the key  .

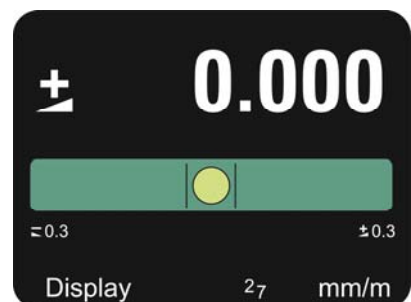

The instrument will return to the measuring mode.

Depending on the number of sensors selected the choice of display types in the BlueMETER SIGMA is varying.

For one only selected sensor or two sensors in differential mode the following displays are available:

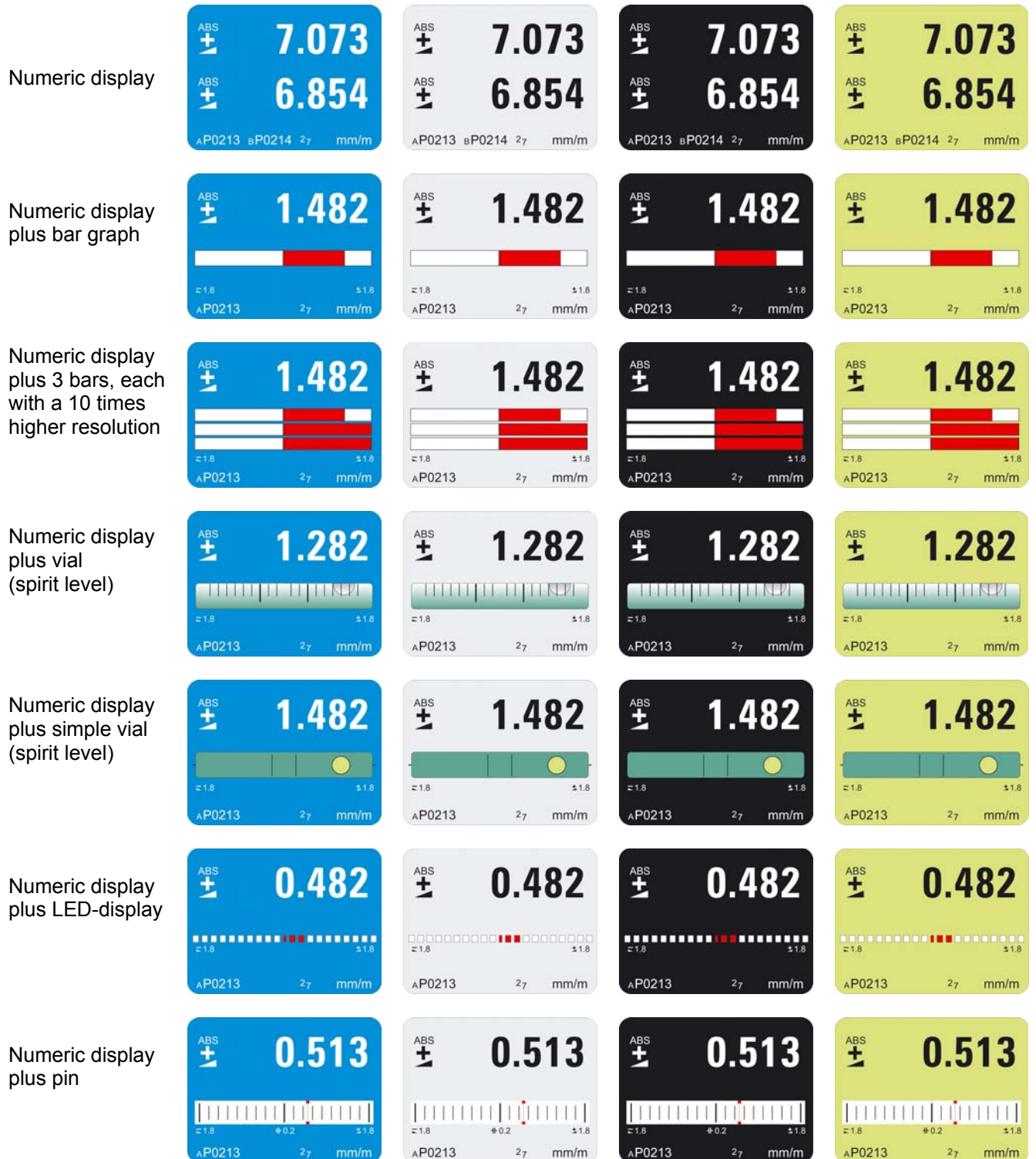

For two selected sensors or four sensors in differential mode the following displays are available:





For three or four selected sensors the numeric display is available:



4.2.3 BACKGROUND COLOUR

In the adjustments of the instrument the background colour can be selected. Depending on the brightness of the colour selected the colour of the fonts and the symbols will change between black and white.

Using the key **ON/MODE**  select the menu point [Options] and confirm with **ENTER** . Select now [Display Settings] and confirm with **ENTER** .

With the keys **ZERO/SELECT**   select the display colour and confirm the selection with the key **ENTER** .

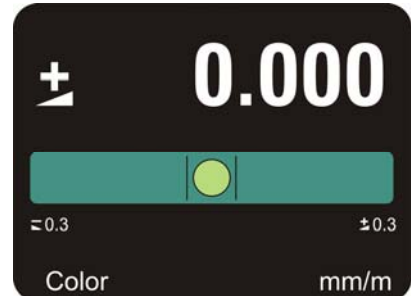

The instrument will return to the measuring mode.

The following background colours are available in the BlueMETER SIGMA:

Background colour blue



Background colour black

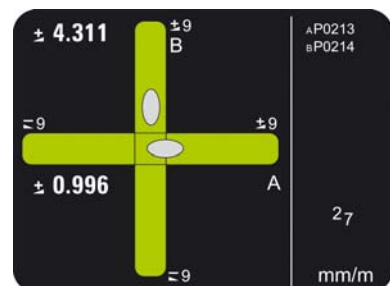

Background colour beige

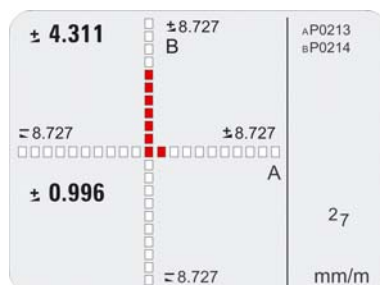



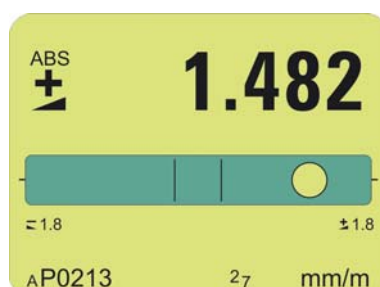



Background colour green













4.2.4 BRIGHTNESS OF THE DISPLAY



Adjustment of the brightness of the display. Difference between battery operation and the use of an external power supply.

In the adjustments of the instrument the brightness of the display can be adjusted in order to adapt it to the environmental conditions and to optimise the battery life time. Thus two different values can be set for the battery operation and the operation with an external power supply

Using the key   select the menu point [Options] and confirm with  . Select now [Display Settings] and confirm with  .

Using the keys    select [Brightness] for the adjustment when using an external power supply and [Brightness Powersave] for the adjustment in battery operation. Confirm this selection with  .

With the keys    you can adjust the brightness required. The display will show the power consumption in a range from 10% to 100% of the maximum brightness. Only steps of 10% are possible. Confirm the adjustment with the key  .

With the key   the default value of 50% will be recalled.

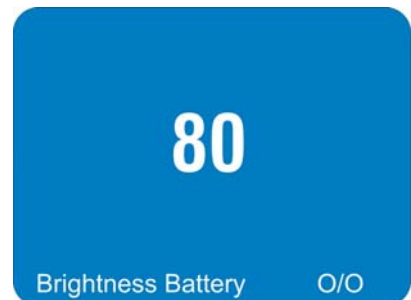







The instrument will return to the measuring mode.





4.2.5 SHORT DESCRIPTION OF THE INDIVIDUAL DISPLAY AREAS

Main display

In the main display the actual measuring value will be displayed.

Display of the direction of the inclination	<p>A symbol indicates the direction of the inclination of the value displayed.</p>
	<div style="display: flex; align-items: center;">  <div style="margin-left: 20px;">inclined to the right (positive inclination)</div> </div> <div style="display: flex; align-items: center; margin-top: 10px;">  <div style="margin-left: 20px;">declined to the right (negative inclination)</div> </div>
on hold	<p>The HOLD function is activated, i.e. the measuring value is "frozen".</p>
ABS	<p>Absolute measurement is activated.</p>
REL	<p>Relative measurement is activated, i.e. the measuring value is the difference between the current and the reference plane, i.e. the relative base.</p>
displaying range 60°	<p>Shows the selected displaying range. The displaying range can be adjusted using the keys ZERO/SELECT   provided that this function is enabled in the options.</p>
scale division 5°	<p>Angle between two tick marks</p>
Scale division LOG	<p>Indicates that the logarithmic scale is in use. If this sign is missing, the linear scale is in use.</p>
Serial number	<p>Shows the serial number of the instrument</p>
Gravity 	<p>Correction of a different gravity force is on.</p>
Battery voltage 2 ₆ Power supply 	<p>Display of the current battery voltage (example 2.6 V). The lowest possible voltage is 1.7 Volt. After a further voltage drop a blinking battery symbol will appear. The batteries must then be exchanged immediately. A plug symbol will appear when the instrument is powered with 24V by an external source. The symbol a white five on black background indicates a 5V external source.</p>
Measuring unit	<p>Display of the measuring unit in use. There are 10 basic units available, whereas for each setting various options can be selected.</p>

4.3 OPERATING INSTRUCTIONS BLUEMETER SIGMA

The BlueMETER SIGMA offers a wide range of functions and adjustment possibilities. The list of functions appears when the key **ON/MODE**  is pressed. With the keys **ZERO/SELECT**   the desired function can be selected and with **ENTER**  it will be started. If during 10 seconds no further key is operated, the function list will be left. With the key **SEND/ESC**  a function selected can be abandoned. Already entered changes of parameters will be rejected and the BlueMETER SIGMA will return to the previously used display mode.

Here after the single functions will be described.

4.3.1 FUNCTIONS ON THE BLUEMETER SIGMA / OVERVIEW KEYS AND DISPLAY

Function circle according to G. Lasczyk ... using the key **ON/MODE** 

OPTIONS:

- Set Pin-Code
- Display-Settings
- Logscale
- Programmable Keys
- Functions ON/OFF
- Hide disabled
- Radio ON/OFF
- Gravity
- Version SW
- Factory Reset
- Self Test

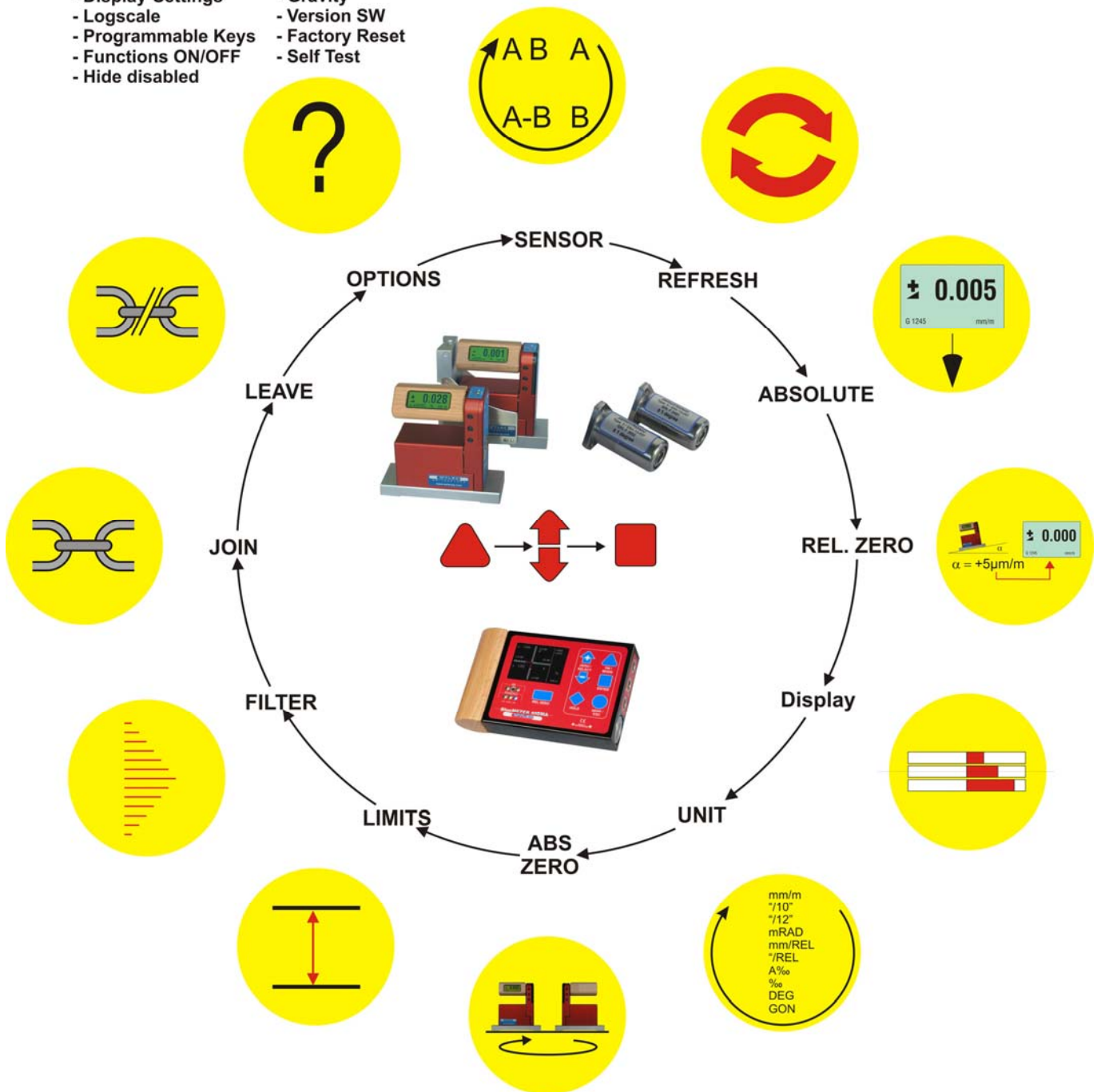





The following functions are available:



- **Refresh**
Starts the search for instruments connected and registers them in the internal list of instruments. Instruments not connected any more are marked in the list of instruments as "not present". To make a later search easier these remain, however, in the list.
- **Sensor**
Adjustment of the measuring mode and assigning the measuring instruments resp. sensors.
- **Absolute**
Absolute measurement is activated and relative measurement is disabled.
- **Rel. Zero**
Relative measurement is activated and the relative inclinations are read respectively pre-set.
- **Display**
Selection of the display graph
- **Unit**
Selection of the measuring unit displayed
- **Abs. Zero**
Absolute measurement is activated and the Zero-offset is determined respectively set.
- **Limits**
Enabling and setting of Limits for the supervision of the inclinations
- **Filter**
Setting the filter type for the measuring values
- **Join**
Grouping of instruments
- **Leave**
Deleting of a grouping
- **Options**
Setting and adjustment of additional settings

4.3.2 STARTING THE BLUEMETER SIGMA

4.3.2.1 START WITH UNCHANGED CONFIGURATION

Using the key   start the BlueMETER SIGMA and the measuring instruments connected.

Keep the key   pressed until the display and all LEDs are lit and release the key. The display shows shortly a grey screen and changes to the initialisation. After the start you can see the actual measuring values with the last used configuration and measuring unit. In battery operation instrument will automatically shut off after 60 minutes.

If the key   is pressed **for more than 10 seconds** all LEDs start blinking and the **automatic OFF function is deactivated**.



After a self check the BlueMETER SIGMA is initialising itself.

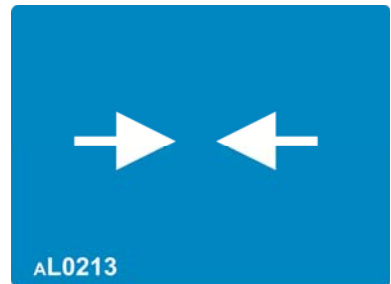
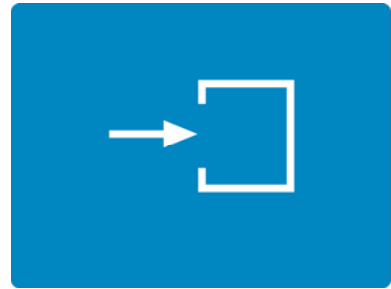

The BlueMETER SIGMA tries to build up a connection with the measuring instruments resp. sensors connected prior to switching it off. For each instruments selected in the function "sensor" a pair of arrows will be shown in the display.



The measuring mode memorised before switching the instrument off will be started and the measuring instruments resp. sensors will be called. If the configuration is still identical to the one during the last performed measurement, the measurement is started.

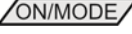

4.3.2.2 START WITH A CHANGED CONFIGURATION

Using the key   start the BlueMETER SIGMA and the measuring instruments connected.

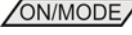
Keep the key   pressed until the display and all LEDs are lit and release the key. The display shows shortly a grey screen and changes to the initialisation. After the start you can see the actual measuring values with the last used configuration and measuring unit. In battery operation instrument will automatically shut off after 60 minutes.

If the key   is pressed **for more than 10 seconds** all LEDs start blinking and the **automatic OFF function is deactivated**.

After a self check the BlueMETER SIGMA is initialising itself.



The BlueMETER SIGMA tries to build up a connection with the measuring instruments resp. sensors connected prior to switching it off. For each instruments selected in the function "sensor" a pair of arrows will be shown in the display.

If the configuration has changed or if one of the measuring instruments is out of reach the following sequence will start.

- The picture to the right indicates that the measuring instrument resp. the sensor has not been found.
- The searching procedure starts again

Check the configuration!

If this has changed, the measuring instruments resp. sensors must newly be connected.

Using the key   you get to the function [Sensor] and with a further keystroke to the selection of functions.

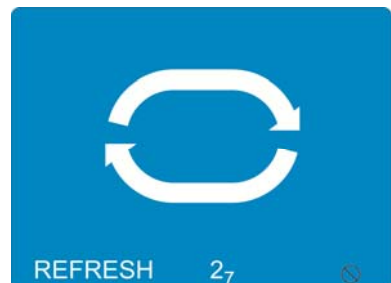
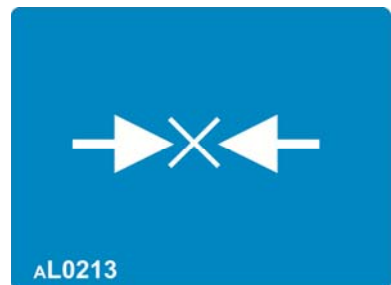
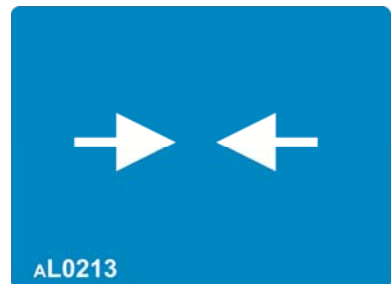
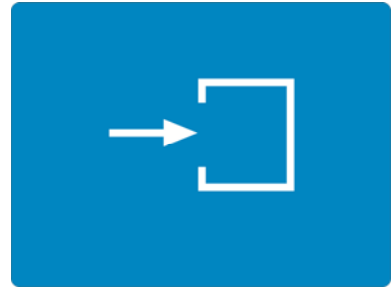

4.4 REFRESH

Starts the search for instruments connected and registers them in the internal list of instruments. Instruments not connected any more are marked in the list of instruments as "not present". To make a later search easier these remain, however, in the list.

The function "REFRESH" must be performed each time new instruments have been connected.

If BlueLEVEL or BlueTC instruments are used which have never before been connected to this BlueMETER SIGMA, these must be integrated one by one. After each new instrument connected to a cable the function "REFRESH" must be performed.



After the "Refresh" the instrument will automatically start the function "sensor" and waits for the selection of the measuring mode and the sensors.

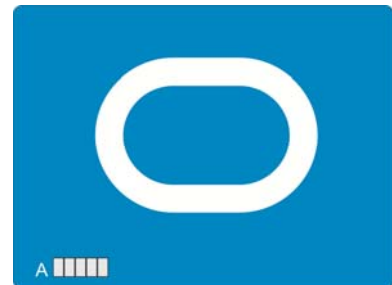



4.5 SENSOR

Here you can select the measuring mode, i.e. single or differential display as well as make adjustments to the active sensors/ports. The following measuring modes are possible:

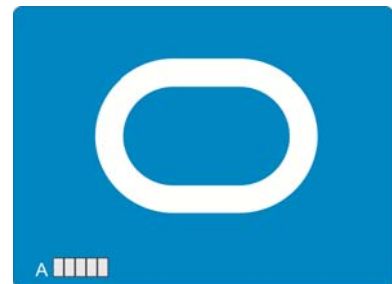
- Measuring instrument/sensor Port "A"
- Measuring instrument/sensor Port "B"
- Measuring instrument/sensor Port "A" – instrument Port "B"
- Measuring instruments/sensors on Port "A" und "B" simultaneously
- Measuring instruments/sensors on Port "A", "B" and "C" simultaneously
- Measuring instrument/sensor Port "A" – instrument Port "B" and Measuring instrument/sensor Port "C" – instrument Port "D" simultaneously
- Measuring instrument/sensor Port "A", "B", "C" and "D" simultaneously







Using the key **ON/MODE**  you get into the menu With the keys **ZERO/SELECT**   select the menu item [sensor]. The following picture will appear.

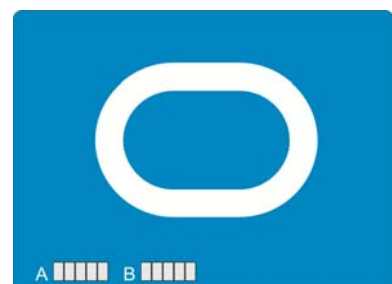

As a first step you can define the measuring mode using the key **ON/MODE** , whereas only those measuring modes are shown which are possible based on the number of measuring instruments resp. sensors.



Confirm the configuration selected with **ENTER** .

The address of the sensor "A" can now be selected with the **ZERO/SELECT**   keys. Confirm the selection with the key **ENTER** .



The remaining measuring instruments resp. sensors can be connected with the same procedure.

When you start the instruments again with the same measuring configuration a selection as described above is not necessary again. The last used configuration will automatically be re-started.

Now the measurement starts.

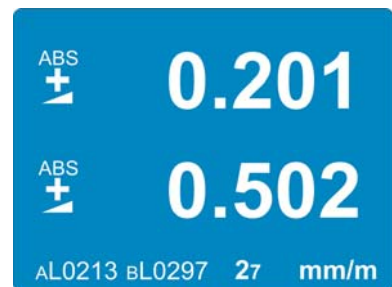

4.6 ZERO-SETTING / ABSOLUTE ZERO

Absolute ZERO means that the instrument shows the measuring value "0" if the measuring surface of the instrument/sensor is aligned exactly according to gravity (true horizontal or true vertical).

4.6.1 SET ABSOLUTE ZERO (WITH A REVERSAL MEASUREMENT)

The absolute zero is used as the base for absolute inclination measurements. In order to achieve the best possible precision please observe that the measuring object (support) and the measuring instruments and/or sensors connected have the same temperature and that the instrument is in operation for several minutes before starting a measurement. Mark the precise position and particularly the direction of the measuring instruments and/or sensors connected in order to be able to turn the instrument by 180 degrees and to put it in opposite direction at the very same spot.

Example with a BlueLEVEL:

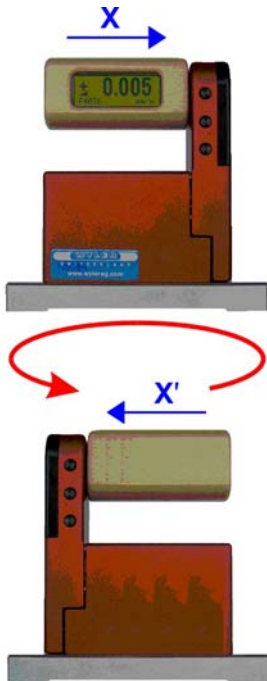

Reversal measurement to determine

- I. the Zero offset of the measuring instrument N_m
- II. the inclination of the supporting surface N_p

Zero offset of the measuring instrument N_m :

$$N_m = \frac{X + X'}{2}$$

Inclination of the supporting surface N_p :

$$N_p = \frac{X - X'}{2}$$

EXAMPLE (BlueLEVEL):

Using the key **ON/MODE**  select the menu item [Abs ZERO] and confirm this selection with **ENTER** .

Note:

Several of the connected measuring instruments can be set to absolute Zero at the same time.

In the display the position of the instrument for the first measurement will be shown.

Put the BlueLEVEL to the first position.

Start the first measurement by pressing the key **ENTER**  or with the zapper.

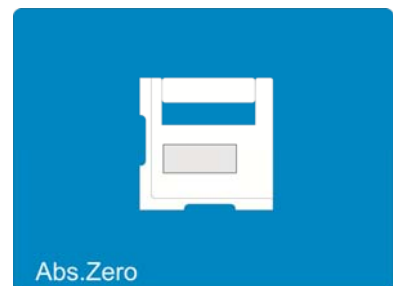

During the measurement the display will graphically show the current measurement.

Confirm the first measurement with the key **ENTER**  or with the zapper. After 15 seconds the value will automatically be read.

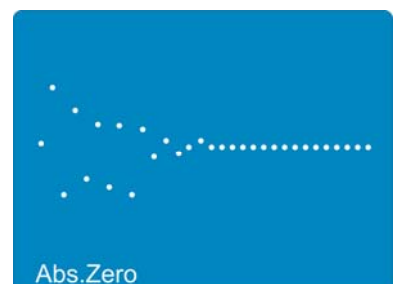

After a successful reading of the first measuring value the position of the instrument for the second measurement will appear in the display.

Put the BlueLEVEL now to the second position (turn the instrument by 180 degrees in the horizontal).

Start the second measurement by pressing the key  or with the zapper.



During the measurement the display will graphically show the current measurement.

Confirm the second measurement with the key  or with the zapper. After 15 seconds the value will automatically be read.



After termination of the reversal measurement the display for the actual measurement under consideration of the ZERO OFFSET will appear on the screen.

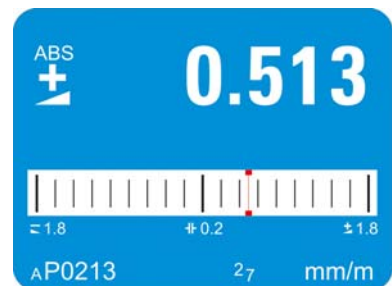

Notice:



The value of the "ZERO OFFSET" determined by a reversal measurement corresponds to the deviation of the zero point of the measuring instrument/sensor compared to the absolute Zero (gravity). The displayed measuring value corresponds to

VALUE displayed =
Value of the measuring instrument minus "Zero offset"

The reversal measurement described above should be repeated periodically in order to achieve a high measuring precision, particularly when the instruments have not been in use for a longer period.

4.7 SELECTION OF THE MEASURING UNIT / UNIT

4.7.1 STANDARD-UNITS

You can change the measuring unit of the inclination values displayed. If you start the function [UNIT] the list of the available measuring units will appear. With the keys **ZERO/SELECT**   you can now select the measuring unit preferred. For memorizing the measuring unit selected you press the key **ENTER** . The measuring unit will remain active until you change it again according to the above procedure.

The following **measuring units** can be chosen:

XXXX.XX	mm/m	mm per m / 2 decimals
XXX.XXX	mm/m	mm per m / 3 decimals
XX.XXXX	"/10"	inch per 10 inches / 4 decimals
XX.XXXX	"/12"	inch per 12 inches / 4 decimals
XXXX.XX	mRad	Milliradian / 2 decimals
XXX.XXX	mRad	Milliradian / 3 decimals
XXXX.XX	mm/REL	mm in relation to the relative base / 2 decimals
XXX.XXX	mm/REL	mm in relation to the relative base / 3 decimals
XX.XXXX	mm/REL	mm in relation to the relative base / 4 decimals
XX.XXXX	"/REL	inches in relation to the relative base / 4 decimals
XXXX.XX	A ‰	artillerie-permille
XXXX.XX	‰	permille
XXX.XXX°	DEG	degrees / 3 decimals
XXX° XX'	DEG	degrees / minutes
XX° XX' XX"	DEG	degrees / minutes / seconds
XXXX' XX"	DEG	minutes / seconds
XXXXX"	DEG	seconds
XXXXX.X"	DEG	seconds / 1 decimal
XXX.XXX	GON	gon / 3 decimals



4.7.2 UNITS WITH RELATIVE BASE LENGTH

The units mm/REL and "/REL are related to a relative, this means selectable, base length of the measuring instrument connected. After selecting one of these units, the relative base length must be entered.

Example: **mm/REL** / mm in relation to a relative base / 2 decimals.

After the selection of the measuring unit in our example the stored base length of 1000 mm will appear.



With the keys **ZERO/SELECT**   the proposed base length can be modified. The newly entered value can finally be confirmed with the key **ENTER** .

With the key **ON/MODE**  the default value 1000 mm will be recalled.



The following measurements are now related to a base length of 1250 mm.



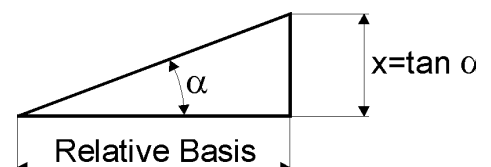

When measuring in the "relative mode" the height "X" will be displayed as linear measure in the selected unit and in relation to the set base length (in **mm** or **inches**).







4.8 FUNCTION HOLD

The key function   can be applied in all measuring modes.



Put the measuring instrument on a stable support. Press now the key  . While the BlueMETER SIGMA is waiting for a valid measuring value the display will show graphically the measuring values read in the form of a shoal of points. As it is practically impossible to obtain a valid measuring value during manipulation, the instrument can be set to the final position even after activating the key.

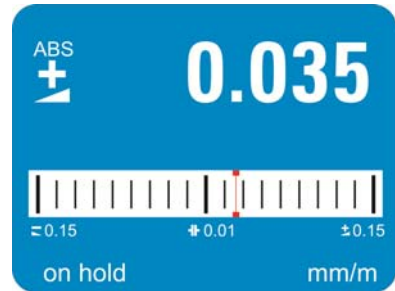

Complete the measurement with the   key or with the zapper. After 15 seconds the measuring value will automatically be read.

By pressing the key   again a new valid measuring value will be read.



With the key   the "frozen" measuring value will be transmitted via the "RS485" port to a connected PC/Laptop with an RS232 interface. At the same time the instrument will return to the measuring mode.

The function SEND can also be initiated from the PC/Laptop connected by sending "P" (as a letter) via the RS 232 port.

4.9 SELECTION OF THE FILTER UNDER DIFFERENT MEASURING CONDITIONS / FILTER





A number of different predefined filters can be selected.

Description of the different filter types:

- FILTER 1: No filtering, no integration of the measuring values (T const. = 0.33 sec.)
- FILTER 2: Floating average of 3 measuring values (T const. = 1 sec.)
- FILTER 3: Floating average of 15 measuring values (T variable = 0.33 ... 5 sec.)
- FILTER 4: Floating average of 6 measuring values (T const. = 2 sec.)
- FILTER 5: Floating average of 15 measuring values (T const. = 5 sec.)

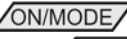
T: Response time when changing the position. For filter 3 the actual change of the measuring value will define the number of values to be used for calculating the floating average. With a considerable change the number of values will be reduced with minute fluctuations the number will be increased.

Filter type 3 is the factory setting when leaving WYLER AG.

With the key   select the menu item [FILTER] and confirm this selection with  .

Using the keys    you can now select the filter type desired and then confirm it with  .

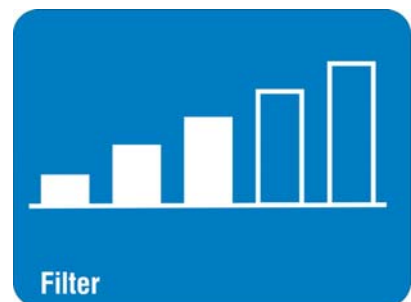



The measuring instrument will return to the measuring mode.

4.10 ABSOLUTE MEASUREMENT / RELATIVE MEASUREMENT

4.10.1 ABSOLUTE MEASUREMENT

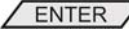
As a factory setting the BlueMETER SIGMA will be programmed for absolute measurement (default setting).

If this is not the case select the function [Absolute]. After confirming this function with the key   the instrument is ready for measurements in the mode "ABSOLUTE".

The measuring value corresponds to the

value of the measuring instrument minus "ZERO - OFFSET"

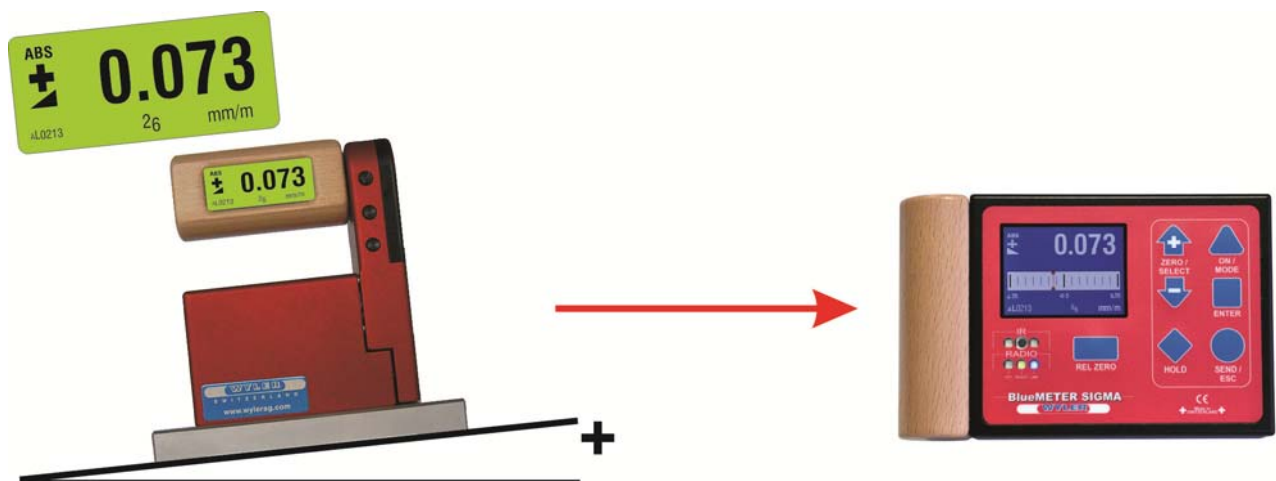

4.10.2 RELATIVE MEASUREMENT / REL ZERO

Important preliminary remark:

The "REL ZERO OFFSET" determined for a relative measurement will be superposed to the "ZERO OFFSET", e.g. determined by a reversal measurement.

The "REL ZERO OFFSET" will be stored in the BlueMETER SIGMA and can be re-called again and again. When starting the next relative measurement the "REL ZERO OFFSET" entered or determined the last time will be displayed. The value can be confirmed, newly entered or set to zero.

Value displayed =
Value of the measuring instrument - "ZERO-OFFSET" - "REL ZERO OFFSET"

Procedure with the key  with one measuring instrument/sensor connected:

Put the measuring instrument on the reference surface. The display shows the value +0.073 mm/m. This corresponds to the absolute inclination of the reference surface.

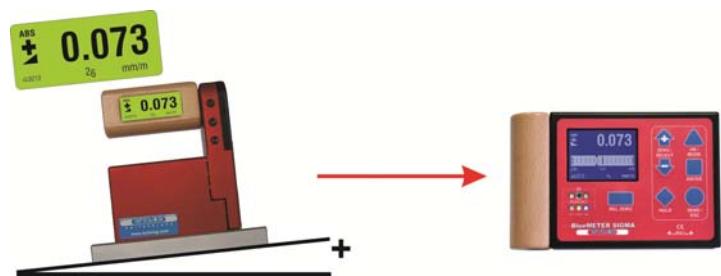

Press now the key  on the BlueMETER SIGMA

In the display you will see the picture to the right

The display will show graphically the measuring values read in the form of a shoal of points.

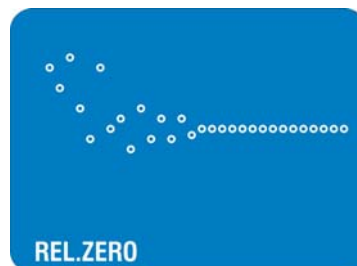

Complete the measurement with the key  or with the zapper. After 15 seconds the measuring value will automatically be read.





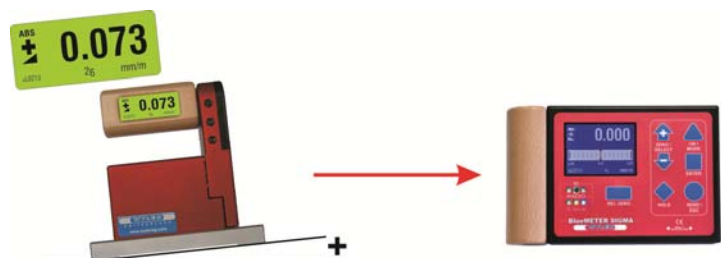

On the screen of the BlueMETER SIGMA now the display for the actual measurement will appear under consideration of the ZERO OFFSET.



The **value displayed** on the BlueMETER SIGMA is now "0" and corresponds to the inclination of the reference surface. On the measuring instrument the value remains +0.073 mm/m. This corresponds to the absolute value of the instrument.







The values for "ZERO" and/or "Relative ZERO" stored in the BlueMETER SIGMA can manually be amended or deleted as follows:

Using the key   select the function [REL ZERO] or [ABS ZERO] and confirm this selection with  . Press again the key  .

The offset value stored will now be displayed.







With the key   the values can be set to "0".





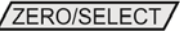

With the key   the new offset values will be determined from the present inclinations of the measuring instruments and then displayed.

With the key   the values displayed will be stored and the procedure will be completed.

With   the procedure can be abandoned without any change.

After that the BlueMETER SIGMA will return to the measuring mode.

With one of the keys    you get to a menu where you can select an offset and modify it manually. Select the sensor required with the keys    and press the key  .

Adjust now the value with the keys    to the value required. Confirm this value with the key  . With the key   you can newly determine the corresponding offset.





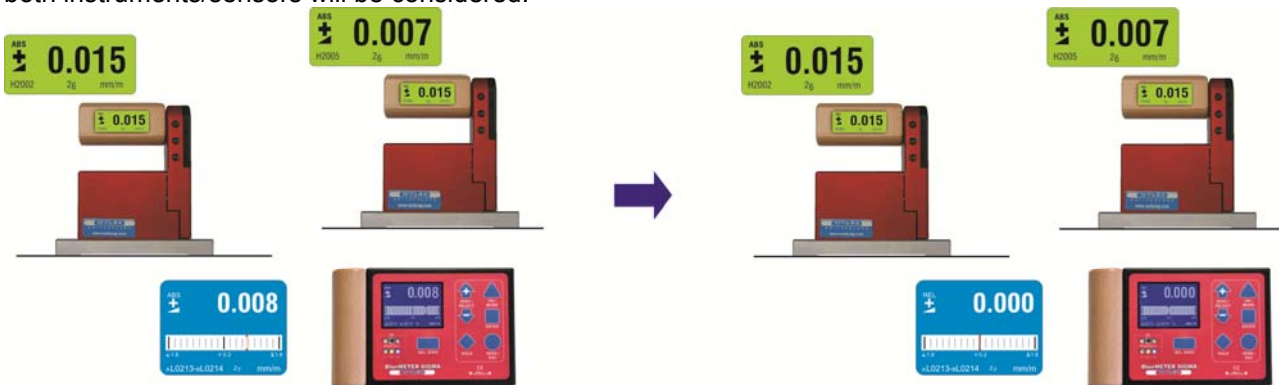

(not realised yet)

Use this procedure when you have to set one of these registers to a specific value, e.g. exactly 5°.

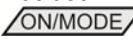
Procedure with the key   with two measuring instruments/sensors connected:

The procedure is similar to the procedure described above with the difference that the inclination values of both instruments/sensors will be considered.





Put both instruments in position. With the key   select the menu [REL.ZERO]. and confirm with   or use the key  .

As a first step the picture to the right will appear on the display

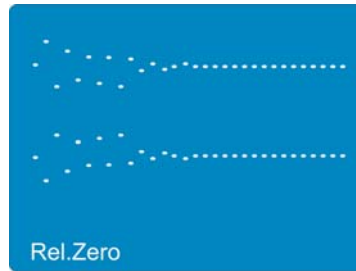

With the key  or with the IR zapper you can confirm the selection. The actual measuring values are continuously read and displayed in the form of a shoal of points.



As soon as the value is stable the value for the relative Zero (REL ZERO) can be read in with the key  or with the IR zapper.

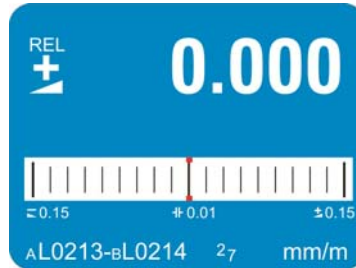

In the display of the BlueMETER SIGMA the value "0.000" is now displayed, i.e. the absolute value under consideration of the relative offset. This value serves as the reference for the subsequent measurements.

IMPORTANT:



The display on the measuring instruments (BlueLEVELs) continue to show the actual **absolute measuring values** in the absolute mode.









4.11 MEASURING WITH LIMITS / LIMITS

(not realised yet)

If you intend to set off an "Alarm" when a defined limit is exceeded this can be realised using the function "LIMITS".

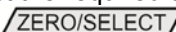

The function "LIMITS" allows defining an upper and a lower **limit** on the BlueMETER SIGMA. If this set limit is exceeded respectively under-run, a horizontal bar in the display will start blinking. A blinking bar above the displayed value means that the upper limit has been exceeded. If the blinking bar is below the lower limit has been under-passed. Through the RS485 port a message will be sent.

Using the key  select the menu item [LIMITS] and confirm this selection with .

Switch the function [LIMITS] on or off using the    keys and confirm with the key . Select the required sensor respectively the measuring channel using the keys    and confirm the selection with the key .



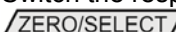



Switch the respective limit ON or OFF using the keys

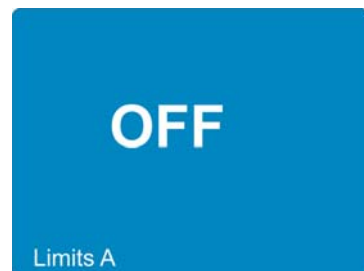



  .

With the key  you get to the entering mask of the lower limit.



The value is adjusted using the **ZERO/SELECT**   keys. Confirm the value with the key **ENTER** . With the key **ON/MODE**  the default value will be recalled.



Now you can enter the upper limit. The value is adjusted using the **ZERO/SELECT**   keys. Confirm the value with the key **ENTER** . With the key **ON/MODE**  the default value will be recalled.



The measuring instrument will return to the measuring mode.

If during the measurement the lower respectively the upper limit is exceeded a blinking horizontal bar will appear above respectively below the inclination value. Via the RS485 port a respective message will be sent.

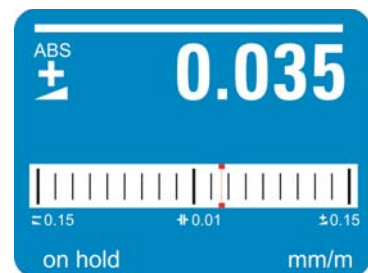

It is possible to set the lower limit above the upper limit. In this case a respective message will be sent via the RS485 port continuously.



Data format at the RS 485 interface

```
Upper Limit [sss xxxxt UL sn.nnnnnn sm.mmmmmm<cr>]
Lower Limit [sss xxxxt LL sn.nnnnnn sm.mmmmmm<cr>]
sss =      0 .. 255 - continuous number
xxxxt =    Sensor Serial Number and Type
N2673L    BlueCLINO
sn.nnnnnn = +9.999999 - Positive Overage
           -9.999999 - Negative Overage
           other value - angular value in rad, e.g. +0.226349
sm.mmmmmm = limit defined
```



4.12 GROUPING AND UNHINGING OF A MEASURING GROUP (JOIN/LEAVE)

4.12.1 PROCEDURE "JOIN" VIA CABLE CONNECTION

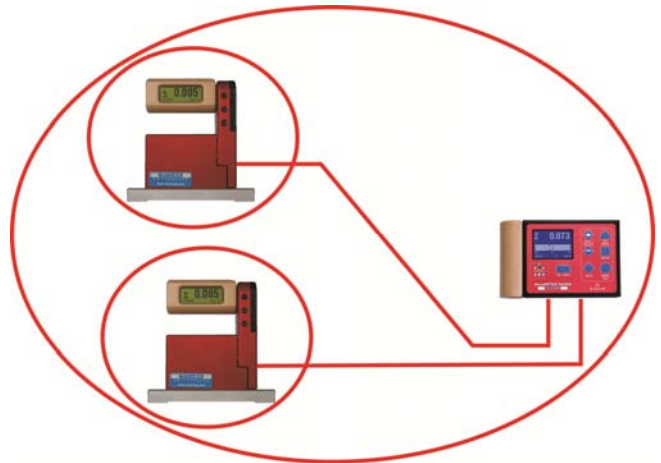

(EXAMPLE WITH BLUELEVEL AND BLUEMETER SIGMA)

1. Connect all instruments to be grouped (BlueLEVEL and BlueMETER SIGMA) using the cables provided and switch all instruments on.
2. Select on the BlueMETER SIGMA the menu "JOIN" using the **ON/MODE**  key. Confirm with the key **ENTER** . All instruments connected are now searched and joined to a group.
3. After establishing the group a "REFRESH" will be performed.
4. After a successful grouping the command "SENSOR" will be performed. As the measuring mode has not been set yet, the message "not defined" will be displayed.



5. The measuring mode ("A", "B", "A B" or "A-B") must now be defined. Select the desired mode with the keys **ZERO/SELECT**   (corresponds to the menu [SENSOR]) and confirm with **ENTER** .

It is also possible to execute any other function of the menu. For instance it is possible to integrate with further "JOIN" commands additional instruments with wireless connection into the group

6. The sensors must be selected. Select the sensors for A and - depending on the measuring mode - also for B using the key **ZERO/SELECT**   and confirm with **ENTER** . The measuring values are now shown in the display according to the selected configuration.
7. After a successful grouping on both instruments the green LED "READY" will blink shortly as many times as instruments are joined in the measuring group (including the own address).
8. For using the wireless mode (the wireless mode must be switched-on on each instrument) the cables can now be removed. After removing the cables the measuring values will be "freeze" for a short while and replaced by empty zeroes until, after successful connection, the measuring values will be displayed again
9. After successful connection the blue LED "LINK" will be lighting on all the instruments connected.



4.12.2 PROCEDURE "JOIN" WITH WIRELESS DATA TRANSMISSION

With the function "JOIN" an instrument can be added by wireless data transmission to an existing group. During this procedure no instrument must be connected by cables as otherwise the "JOIN" procedure for cables will be performed.

IMPORTANT:

Only two instruments can be grouped in one procedure. If more instruments are members of a measuring group, e.g. a BlueLEVEL "1", a BlueLEVEL "2" and a BlueMETER SIGMA it is recommended to group first the BlueLEVEL "1" with the BlueMETER SIGMA and then the BlueLEVEL "2" also with the BlueMETER SIGMA. The affiliation to the measuring group will be communicated between the members.

The <ON/MODE> key must be pressed repeatedly until the mode [JOIN] appears in the display. Confirm with <ENTER>

1. The **two instruments to be grouped** must be set to the **JOIN-mode**. The  key must be pressed repeatedly until the mode [JOIN] appears in the display. Confirm with .

2. **Searching**

Both instruments are "searching" each other. During the searching procedure the green LED on both instruments are lit continuously. The instruments remain in the "search" mode until they have detected each other.

During the search process the following picture will be displayed

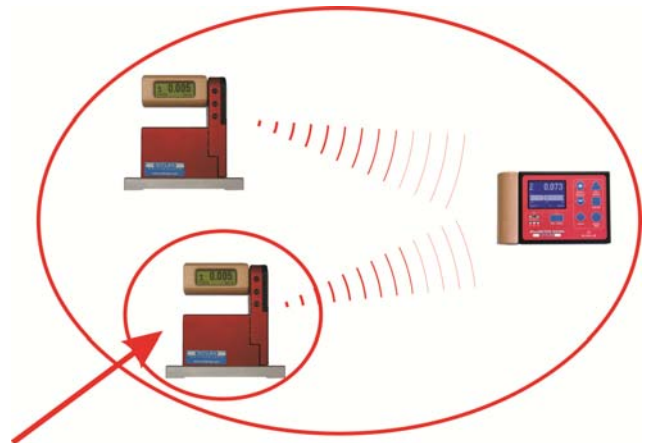





Remark: The searching process may go on for several minutes in bad communication conditions.

3. **Group connection**



As soon as the two instruments have successfully detected each other the search process is stopped and this is visualised by a rapid blinking (4 to 5 times per second) of the green LED's on both instruments.. The joining can no be activated by

- using the  key on one of the instruments
or

- the whole process may be cancelled after some seconds by pressing one of the  or the  keys.

4. After establishing the group a "REFRESH" will be performed.
5. After the grouping the command "SENSOR" will be performed. As the measuring mode has been cancelled during the JOIN procedure this mode must be selected again. The message "not-defined" will be displayed.
6. The measuring mode ("A", "B" or "A-B" must now be selected. Select the mode preferred using the  keys (corresponding to the menu [SENSOR]) and confirm with .

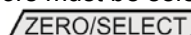
It is also possible to execute any other function of the menu. For instance it is possible to integrate with further "JOIN" commands additional instruments with wireless connection into the group

7. The sensors must be selected. Select the sensors for A and - depending on the measuring mode - also for B using the  keys and confirm with . The measuring values are now

shown in the display according to the selected configuration.

8. After a successful grouping on both instruments the blue LED "LINK" will be lit continuously. The green LED "READY" will blink shortly as many times as instruments are joined in the measuring group (including the own address)

Attention: If the LED "OFF" is blinking in red, a connection is not possible (see chapter 2.4.2 / special case)

4.12.3 SPECIAL CASES "JOIN"

In case both instruments are already joined in different groups of instruments they do find each other but they can not communicate together. The red LED "OFF" is blinking. The search process may be cancelled by using the key

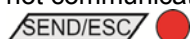



If it is required to use one of the instruments in the new measurement group it is necessary to use the mode "LEAVE" to cancel the existing connection.

4.12.4 UNHINGE AN INSTRUMENT IN THE RADIO MODE FROM A GROUP BY USING THE FUNCTION „LEAVE“

Each instrument may be unhinged from an existing group of connected instruments.

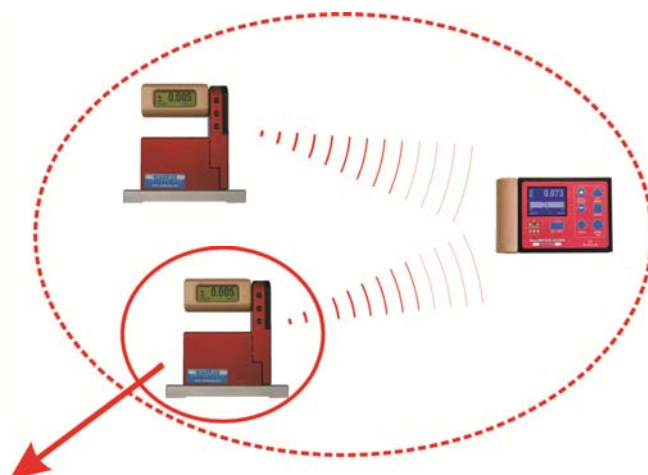
PROCEDURE "LEAVE"

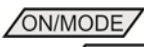

1. If BlueLEVEL instruments are transmitting measuring values to a BlueMETER SIGMA or a BlueTC, the keys on the BlueLEVELs are locked. To unlock a BlueLEVEL, the settings at the BlueMETER SIGMA have to be changed in such a way that it no longer communicates with this BlueLEVEL.
2. On the instruments to be disconnected the  key must repeatedly be pressed until in the display shows the mode **[LEAVE]**. Confirm with .
3. During the leaving mode the blue LED is blinking under "LINK", the green LED "READY" is blinking respectively off
4. After the successful procedure the green LED is blinking once for approx. 1 second. With this the unhook process is finished.





4.12.5 RENEWED CONNECTION OF A MEASURING GROUP

After a measuring group has been stopped e.g. after the termination of a measurement, the group of instruments remains intact. After the restart the communication is automatically activated and the communication is started. The process JOIN must not be repeated.

4.13 TEACH-IN of the IR-trigger (Zapper)

In order to eliminate interference of the zapper signals when several measuring groups are active in the triggering range the IR trigger can be assigned to a specific measuring group by applying the function TEACH-IN

Procedure **TEACH-IN**:

- The measuring or display instrument must be started
- Keep one of the keys      on the measuring or display instrument pressed
- Point the trigger (IR Zapper) in the direction of the measuring or display instrument
- Press the **actuator key** on the IR Zapper until both red IR LED's are lighting up

This procedure must be done on all the measuring and display instruments using the same IR triggering. When the instruments are dispatched this procedure is already factory set standard.



5 OPTIONS







The options serve for entering the basic adjustments of the measuring instrument. The access to the options can be protected with a PIN code in order to avoid unauthorised modifications.

The following options are available:





- **Option "Set PIN-Code"**
With this option it is possible to block the entering of options with a PIN code.
- **Option "Display Settings"**
With this option basic settings of the display, such as the brightness and colour pattern, are possible.
- **Option "Logscale ON/OFF"**
With this option the logarithmic scaling can be switched on or off.
- **Option "Programmable Keys"**
With this option it is possible to switch the scale-functions of the keys <ZERO/SELECT> and the functions of the key <REL ZERO> on or off.
- **Option "Functions ON/OFF"**
With this option specific functions can be switched on or off. Functions switched off will appear in the main menu in grey fonts only.
- **Option "Hide disabled Functions ON/OFF"**
If this option is enabled, disabled functions will not be shown.
- **Option "Radio ON/OFF"**
With this option the wireless data transmission can be activated or deactivated.
- **Option "Auto Address ON/OFF"**
With this option the automatic assignment of the RS485 device address can be switched on or off.
- **Option "Set Address"**
With this option the RS485 address of a single sensor can be read and set.
- **Option "Gravitation"**
With this function the correction of the gravitation can be switched on or off and the local gravity force can be entered.
- **Option "Version"**
With this option the version of the firmware will be displayed.
- **Option "Factory Reset"**
A complete factory reset will set the instrument to the factory (default) settings as it has been configured at the factory. All personal settings are lost.
- **Option "Function Check"**
A function check of the instrument will be performed.



5.1 SET PIN-CODE

In order to protect the settings of the BlueMETER SIGMA against unauthorised changes you have the possibility to block the entering of options with a PIN code.

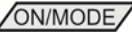
Using the key   select the menu point [Options] and confirm with  . Select now [Set Pin Code] and confirm with  .

Switch the blocking of options with the keys    to ON and confirm with the key  .





You can now enter your PIN code. The value can be adjusted using the keys   . With the key   the standard value 00000 will be recalled.

Confirm your entry with the key  .

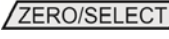

The measuring instrument will return to the measuring mode.

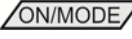
If the option PIN code is activated, the code must be entered before the list of options will be shown.

Entering the PIN code: The value can be adjusted using the keys   . With the key   the standard value 00000 will be recalled.









As a factory setting the PIN code is deactivated. The default value is 00000.

5.2 DISPLAY SETTINGS

The brightness of the display, the brightness in the energy safe mode and the colour pattern can be adjusted individually. The BlueMETER SIGMA will work in the energy safe mode as long as no external power supply is connected and it is powered by batteries. The brightness is indicated as a percentage of the maximum brightness. As the power consumption is considerably reduced with a reduced brightness, it is recommended to use in the energy safe mode a brightness of 50 % (default).







With the colour pattern the background colour can be adjusted. The colour of the fonts changes according to the brightness of the background between white and black. Standard background is blue.

Using the key   select the menu point [Options] and confirm with  . Select now [Display Settings] and confirm with  .



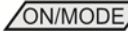



With the keys    select the display option you would like to change and confirm the selection with the key  .

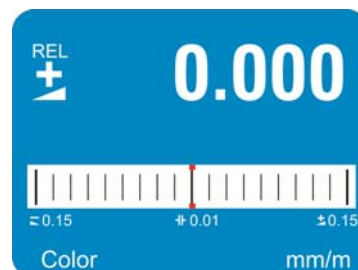

In the brightness adjustments you can increase or reduce the brightness using the keys   . The range is from 10% to 100%. With the key   the default value of 50% will be recalled. Confirm the new value with the key  .









In the colour adjustments you can select the colour preferred using the keys   . Confirm your choice with the key  .





The measuring instrument will return to the measuring mode.

5.3 LOGSCALE

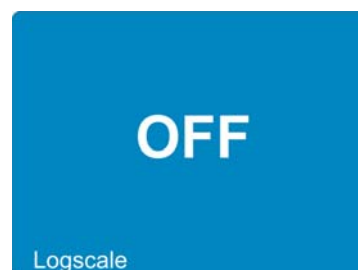
With this option the logarithmic scaling can be switched on or off.

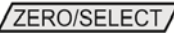

Using the key   select the menu point [Options] and confirm with  . Select now [Logscale] and confirm with  .





Switch the logarithmic scaling ON or OFF using the keys    and confirm with the key  .

The measuring instrument will return to the measuring mode.

5.4 PROGRAMMABLE KEYS

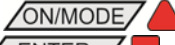
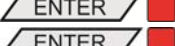
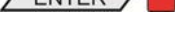
With the keys  the scaling of the display can be adjusted and with the key  a relative Zero can be set. The functions of these keys can be switched on or off.

Using the key  select the menu point [Options] and confirm with . Select now [Programmable keys] and confirm with .

Select the key you want to activate or deactivate using the keys  and confirm your choice with the key .

With the keys  you can switch the selected key ON or OFF. In the display the selected status will be shown. ON means activated, OFF means deactivated. Confirm with the key .

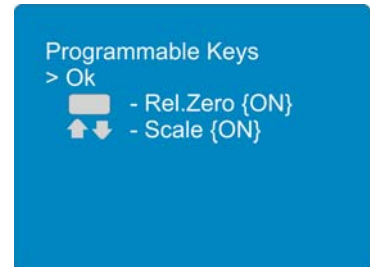

The list of the programmable keys will be shown again. For switching another key on or off, repeat the procedure as described above. In order to store the settings select "Ok" and confirm with the key .

The measuring instrument will return to the measuring mode.





5.5 FUNCTIONS ON/OFF

The menu functions provided can be switched on respectively off. Thus the menu displayed can be adjusted to the needs of the user.

Using the key **ON/MODE**  select the menu point [Options] and confirm your selection with **ENTER** . Select now [Functions ON/OFF] and confirm with **ENTER** .

Select the function you want to switch on respectively off with the keys

ZERO/SELECT   and confirm your selection with the key **ENTER** .

With the keys **ZERO/SELECT**   you can switch the selected function ON or OFF. In the display the selected status will be shown. ON means enabled, OFF means disabled.

Confirm with the key **ENTER** .

The list of the switchable functions will be shown again. For switching another function on or off, repeat the procedure as described above. In order to store the settings select "Ok" and confirm with the key

ENTER .

The measuring instrument will return to the measuring mode.

Functions ON/OFF

> Ok
Absolute {ON}
Rel.Zero {ON}
Display {ON}
Unit {ON}
Abs.Zero {ON}
Limits {ON}
Filter {ON}
Join {ON}
Leave {ON}

ON



Limits



Functions ON/OFF

> Ok
Absolute {ON}
Rel.Zero {ON}
Display {ON}
Unit {ON}
Abs.Zero {ON}
Limits {ON}
Filter {ON}
Join {ON}
Leave {ON}

5.6 HIDE DISABLED FUNCTIONS ON/OFF

This adjustment allows you to hide the functions disabled. The list of functions will only show those functions which are enabled. If this adjustment is not activated, disabled functions will be shown in the list of functions in grey fonts.

Using the key **ON/MODE**  select the menu point [Options] and confirm your selection with **ENTER** . Select now [Hide disabled Functions ON/OFF] and confirm with **ENTER** .

Switch the adjustment "Hide disabled functions" ON or OFF with the keys **ZERO/SELECT**   and confirm with the key **ENTER** .



The measuring instrument will return to the measuring mode.



OFF

Hide Disabled

5.7 RADIO ON/OFF

This adjustment allows you to switch the wireless data transmission on or off.

Using the key  select the menu point [Options] and confirm your selection with . Select now [Radio ON/OFF] and confirm with .



Switch the wireless transmission ON or OFF using the keys   and confirm with the key .



The measuring instrument will return to the measuring mode

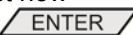

5.8 AUTO DEVICEADDRESS ON/OFF

This adjustment allows you to switch the automatic assignment of RS485 addresses on or off.

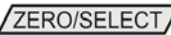
Using the key  select the menu point [Options] and confirm your selection with . Select now [Auto Deviceaddress ON/OFF] and confirm with .

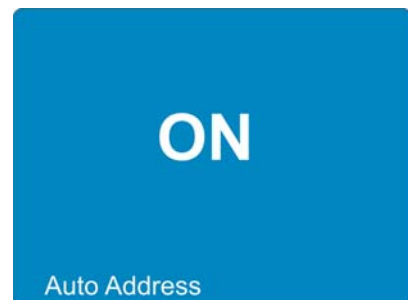

Switch the automatic assignment of RS485 addresses ON or OFF using the keys   and confirm with the key .

The measuring instrument will return to the measuring mode.



5.9 CHANGING SENSOR ADDRESSES

When the automatic assignment is switched off, the RS485 addresses can be assigned manually.

Using the key  select the menu point [Options] and confirm your selection with . Select now [Set Device Address] and confirm with .



The BlueMETER SIGMA searches now all the instruments/sensors connected.



As soon as this search is completed, the list of instruments connected will be displayed. The list is sorted according to the RS485 device address. In case a sensor is connected via a transmission unit, e.g. a BlueTC, this will be shown in the list with the tag "via" plus the serial number of the transmission unit.

With the keys   you can select the instrument, the address of which shall be changed. Confirm the selection with .



With the keys **ZERO/SELECT**   the RS485 device address can be selected whereas only those numbers will be displaced which have not assigned yet.

Confirm the new address with **ENTER** .

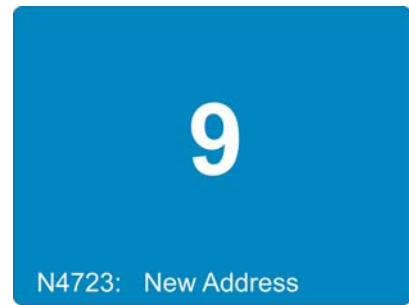

The list of instruments connected will be displayed again. In order to change another RS485 address, please proceed again as described above. If you want to quit the menu, select "OK" and confirm this selection with the key **ENTER** .



The measuring instrument will return to the measuring mode.

In case there is a conflict of addresses this will be shown in the list under the respective RS485 address. If the conflict occurs with a transmission unit, e.g. a BlueTC, this will be shown in the list with the tag "via" plus the serial number of the transmission unit.

A conflict occurs also when the same RS485 address is used for two different transmission units.

Select "Resolve" in order to solve this conflict of addresses or "OK" to return to the measuring mode without memorising the changes.

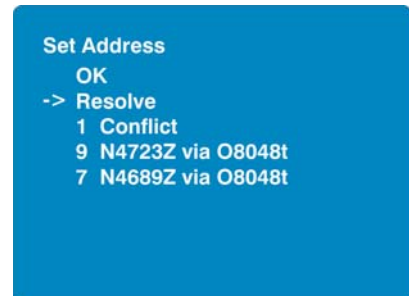

5.10 GRAVITATION

The inclination values transmitted by the measuring instruments and sensors to the BlueMETER SIGMA are based on the gravitation. Around the globe the gravitation is, however, not constant but it varies with the latitude and with the height above sea level. Furthermore variations of the density in the lithosphere cause additional local deviations.

As an example the gravity at sea level is

- 9,78033 m/s² at the equator ,
- 9,80620 m/s² at 45 degree of latitude,
- 9,83219 m/s² at the poles.

In the table to the right the values of gravity for some cities are listed.

The measuring instruments have been calibrated at the head office of WYLER AG.

The inclinations displayed are exact only in this location. In different places the displayed value must be corrected. If the correction of the local gravity is switched on, the inclination measured will be corrected accordingly before the value is displayed.

Amsterdam	9.813	Istanbul	9.808	Paris	9.809
Athens	9.807	Havana	9.788	Rio de Janeiro	9.788
Auckland, NZ	9.799	Helsinki	9.819	Rome	9.803
Bangkok	9.783	Kuwait	9.793	San Francisco	9.800
Brussels	9.811	Lisbon	9.801	Singapore	9.781
Buenos Aires	9.797	London	9.812	Stockholm	9.818
Calcutta	9.788	Los Angeles	9.796	Sydney	9.797
Cape Town	9.796	Madrid	9.800	Taipei	9.790
Chicago	9.803	Manila	9.784	Tokyo	9.798
Copenhagen	9.815	Mexico City	9.779	Vancouver, BC	9.809
Nicosia	9.797	New York	9.802	Washington, DC	9.801
Jakarta	9.781	Oslo	9.819	Wellington, NZ	9.803
Frankfurt	9.810	Ottawa	9.806	Zurich	9.807

The correction is calculated according the following formula:

$$\alpha_{eff} = \arcsin\left(\frac{g_c}{g_m} \sin(\alpha_m)\right)$$





whereas





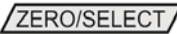

- g_c gravity at the place of calibration
- α_m displayed angle at place of measurement
- g_m gravity at the location of measurement
- α_{eff} effective angle

If measuring instruments like e.g. the BlueCLINO are connected, who are designed to apply this correction themselves, the value for local gravitation will be transmitted to the measuring instrument. For all other measuring instruments and sensors the BlueMETER SIGMA will calculate the correction. This will lead to the effect that different inclination values may be shown on the measuring instrument and on the BlueMETER SIGMA.

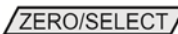
In order to switch the correction of the local gravity on respectively off, proceed as follows:

Using the key   select the menu point [Options] and confirm your selection with  . Select now [Gravity] and confirm with  .

Switch the correction of the gravitation ON or OFF using the keys    and confirm with the key  .

Now you can enter the value of the local gravity. The value is adjusted with the keys   . With the key   the standard value 9.80700 m/s² will be recalled. Confirm your entry with the key  .

The measuring instrument will return to the measuring mode.

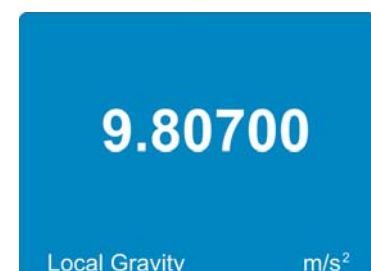

5.11 VERSION FIRMWARE

With this option information about the firmware installed and the configuration can be displayed.

Using the key   select the menu point [Options] and confirm your selection with  . Select now [Version] and confirm with  .

The following information will be displayed:

- Serial number of the instrument
- Number of the Firmware
- Release date of the Firmware
- Type of the instrument (Wireless / Cable)
- Version of the Bluetooth module

Device SN	:	N0012
Firmware	:	269
Date	:	25.10.2011
Type	:	Wireless
Bluetooth	:	3.7.0
Sensor SN	:	
Q.Calib	:	OFF

After 10 seconds or with the key   you leave this display mask.

The measuring instrument will return to the measuring mode.

5.12 FACTORY RESET

A complete factory reset will reset the instrument to the state as it has been configured at the factory. All personal settings are lost.

The BlueMETER SIGMA will be set to the following standard configuration:

Standard-Values:	
measuring mode:	absolute
measuring unit:	DEC xx°xx'xx"
relative base:	1000 mm, 10"
absolute Zero point (ZERO-OFFSET):	0
relative Zero point (REL ZERO-OFFSET):	0
Filter	No. 3
Display	vial
Limits	OFF
Upper Limit	0
Lower Limit	0
Scale	maximum range
Join	not joined
Pin Code	OFF; Code = 00000
Display Settings	Colour Blue; Saturation 100%; Saturation Power Save 50%;
Logscale	OFF
Programmable Keys	all keys enabled
Functions	all functions enabled
Hide disabled Functions	OFF
Radio	ON, if available
Gravitation	OFF; value = 9.807 kg·m/s2

Using the key   select the menu point [Options] and confirm your selection with  . Select now [Factory Reset] and confirm with  .

In order to prevent a resetting by error the question "Are you sure?" will appear. If you really want to delete all personal settings, press now the key .







After 10 seconds or with the key   the instrument will return to the measuring mode.

The measuring instrument returns to the measuring mode.

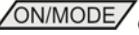

5.13 FUNCTION CHECK

At the start of the instrument a system test will be performed, checking the most important functions. In addition to this test the functions of the keys and of the LEDs can be checked.

Using the key   select the menu point [Options] and confirm your selection with  . Select now [Self Test] and confirm with  .

In the display a simplified design of the front foil of the BlueMETER SIGMA with all the keys and LEDs will be shown.

In an interval of approx. 0.5 seconds the LEDs will light up one after the other whereas the LED lit on the instrument must be identical to the one marked in the display. If this is not the case, the instrument is defective.

If any key or the IR zapper is pressed, the key pressed will be marked. Each key will create an individual pattern. If the key is not marked the instrument is defective.

After 10 seconds without activating any key the instrument will leave the function check mode.

The measuring instrument returns to the measuring mode.

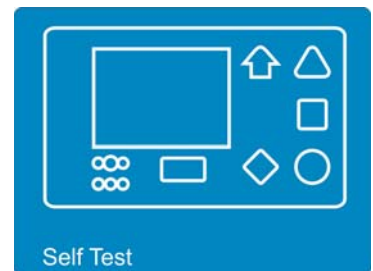

6 BLUETC (TRANSCIVER/CONVERTER) WITH OR WITHOUT RADIO MODULE

The BlueTC with or without radio transmission was developed as an alternative interface to the BlueMETER SIGMA for using the inclination measuring instruments BlueLEVEL.



Functions in connection with BlueLEVEL

The BlueTC can be used with the BlueLEVEL instruments. As all the relevant data such as

- Calibration data
- Instrument's address

are stored in the instrument's memory.

It is possible to send measured data via a RS 232 port to a printer, a PC/Laptop or the WYLER software **LEVELSOFT PRO** and **MT-SOFT** or to other software such as e.g. LabVIEW™

Advantage compared to the BlueMETER SIGMA connected to BlueLEVEL instruments are:

- Simple configuration BlueTC is only an interface between instruments and PC / Laptop
- Cost effectiveness

Disadvantage compared to the BlueMETER SIGMA connected to BlueLEVEL instruments are:

- No display of the connected instruments [A] and [B] measured values
- Menu less extensive and less comfortable due to no display

6.1 INITIAL STARTUP OF THE BLUETC

Please read the manual carefully before working with the BlueTC for the first time.

Starting the BlueTC

Press the key **<ON/MODE>** continuously until all 6 LED's are illuminated then release the key

- The LED "READY" in **STATUS** is flashing rapidly
- The green LED "READY" in **RADIO** is blinking as many times as instruments are connected in the radio mode (inclusive own address)
- In case instruments e.g. BlueLEVEL are already connected by radio the blue LED under **RADIO** is on

Deactivating the automatic instrument shut-off of the BlueTC:

When pressing the **<ON/MODE>** key at the **start of the instrument** longer than 10 seconds all LED's start blinking and the **automatic shut-off** is **deactivated**. In the battery mode, the instrument is automatically shut off after 60 minutes.

Exception:

When the BlueTC is connected to an external power supply the instrument never shuts off automatically (continuous operation).

6.2 TYPICAL CONFIGURATIONS WITH BLUETC

Configurations using BlueLEVEL instruments and BlueTC connected to PC/Laptop

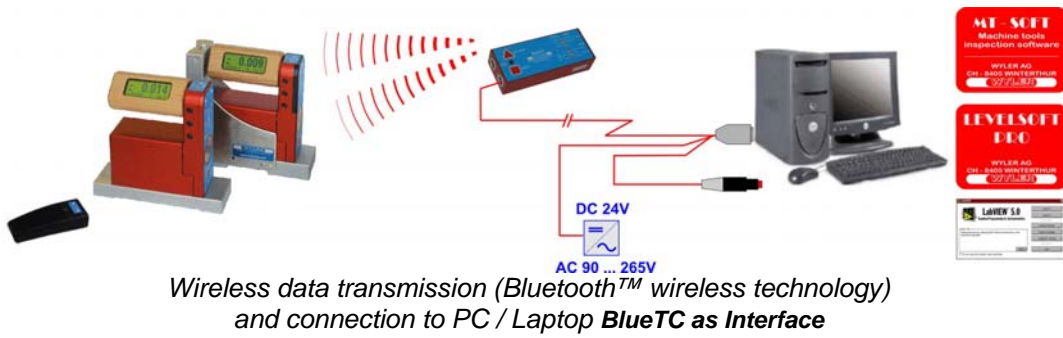
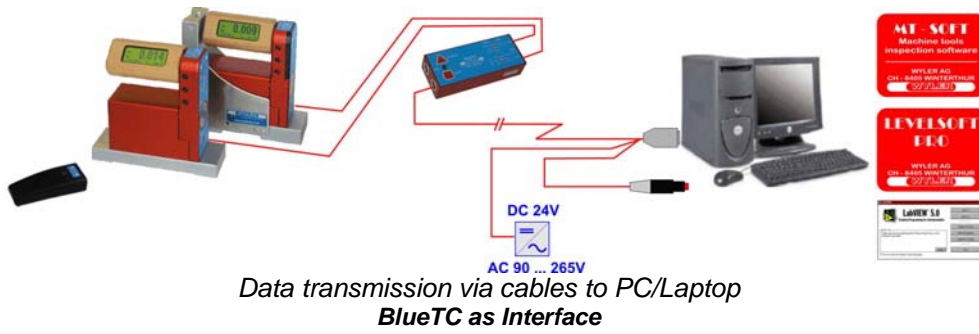

6.3 Overview of the BLUETC

Panel with functional keys

- ON / MODE and
- <ENTER>

LED showing activities of radio transmission, menu structure and infrared contact.

Aluminium housing anodised



Connectors for instruments/sensors/power supply and output to PC/Laptop

The BlueTC is supplied with or without piggy-back mounted power supply

6.4 FUNCTIONAL MENU WITH BLUETC / STRUCTURE

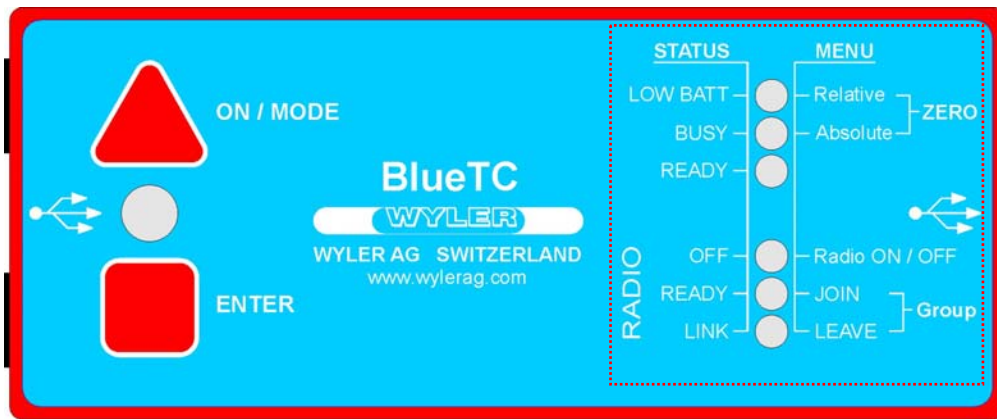

**MENU STRUCTURE
USING THE KEY
<ON/MODE>**

NOTE:

THE FUNCTIONS DESCRIBED HERE AFTER CAN ONLY BE PERFORMED AFTER THE INSTRUMENT HAS BEEN RELEASED BY THE FOLLOWING PROCEDURE:

Press and hold down the <ENTER> key. After 3 seconds press additionally the <ON/MODE> key and hold both down for another 3 seconds. The release both keys at the same time.

With the key <ON/MODE> the corresponding menu can be selected. By means of the key <ENTER> the menu point can be chosen.

MENÜ	Relative ZERO LED red	deactivated
	Absolute ZERO LED yellow	deactivated
	Radio ON / OFF LED red	ON / OFF RADIO (wireless data transmission)
	JOIN GROUP LED green	Joining a measuring group
	LEAVE LED blue	Leaving a measuring group
STATUS	LOW BATT LED red	In case of low battery power the LED glows red
	BUSY LED yellow	Flashing yellow when instrument is busy
	READY LED green	Flashing green when the instrument is ready
	OFF LED red	Red when the radio is OFF
	READY LED green	Flashing green when the radio is ON. The number of impulse indicate the number of instruments joined in the measuring group
	LINK LED blue	Blue when the wireless data transmission is active

6.5 OPERATING THE BLUETC

DESCRIPTION OF THE VARIOUS KEYS



<ON/MODE> - Key

Function - 1 –



Starting the **BlueTC**. Press the **<ON/MODE>** key until all the 6 LED's are illuminated, release key

- The LED "READY" in **STATUS** is flashing rapidly
- The green LED "READY" in **RADIO** is blinking as many times as instruments are connected in the radio mode (inclusive own address)
- In case instruments e.g. BlueLEVEL are already connected by radio the blue LED under **RADIO** is on

Deactivating the automatic instrument shut-off of the BlueTC:

When pressing the **<ON/MODE>** key at the **start of the instrument** for more than 10 seconds all LED's start blinking and the automatic shut-off is deactivated. Normally the instrument is automatically shut off after 60 minutes.

Exception:

When the BlueTC is connected to an external power supply the instrument never shuts off automatically.

Function - 2 –

The key **<ON/MODE>** is used for choosing the corresponding menu point

Function - 3 -

For **shutting off** the BlueTC the key **<ON/MODE>** must be pressed continuously until all 6 LED's are on.



<ENTER> – Key

Function – 1 –

By means of the key **<ENTER>** the menu point can be chosen

Function - 2 -

In connection with the software LEVELSOFT and MT-SOFT the key is used for collecting the actual measured value.

APPENDIX

A BASICS AND GENERAL REMARKS ABOUT BLUESYSTEM AND INCLINATION MEASUREMENT

A1 INTRODUCTION TO THE BLUESYSTEM

The new **BlueSYSTEM** is a continuous further enhancement of the well known and well established measuring instruments MINILEVEL NT + LEVELTRONIC NT with or without wireless data transmission. A BlueSYSTEM normally consists of one or two measuring instruments BlueLEVEL and an indication unit BlueMETER SIGMA. Depending on the application The BlueMETER SIGMA can also be connected to a PC with evaluation software allowing the online evaluation and presentation of the values.

The BlueSYSTEM is available with or without radio transmission. When using the system with cable connections it is possible to upgrade to wireless transmission at a later stage

As its predecessor this newest generation of high precision electronic inclination measuring instruments is specifically suitable for the precision measurement of smallest angles. Applications are therefore in particular the measurement of flatness of surface plates or the measurement of the geometry of machine tools. The sensor itself, the heart of every precision measuring instrument, has been further enhanced as well, to allow precise measurements even under critical environmental conditions.

The key features of these new series of instruments are:

- Compact and pleasant design which is functionally optimized for precision measurement
- Wireless data transmission based on the internationally approved Bluetooth™-standard
- Complete new sensor design
- Sensor as well as amplifying electronic fully sealed and encapsulated in inert gas
- Increased temperature stability
- Increased long term stability
- Large and well readable LCD display
- Display can be read from both sides since the handle can be rotated
- Each instrument has its own specific address allowing the use of several independent systems in the same room without interfering with each other
- Since each instrument has a built in IR receiver, the measurement can be initiated at any instrument
- Compatible to existing measuring bases
- One range only in every instrument
- There are three different BlueLEVEL types available
 - BlueLEVEL 1 µm/m: Range ±20mm/m
 - BlueLEVEL 5 µm/m: Range ±100mm/m
 - BlueLEVEL 10 µm/m: Range ±200mm/m
- Linearity throughout the measuring range according to DIN 2276
- All instruments are equipped with RS 232 / RS 422 / RS 485 interfaces
- Powered by standard 1.5 V batteries type "C"
- In compliance with CE regulations and other applicable EMC regulations

The new measuring instruments of the BlueSYSTEM family can be used as individual instruments as well as combined in a set. Instead of using a BlueMETER SIGMA it is also possible to use a BlueTC as an interface to the PC/Laptop. The functions are all the same with the exception of the LCD display which is only available with the BlueMETER SIGMA.

A set of instruments, also called ENGINEER SET, normally consists of one or two BlueLEVEL and one BlueMETER SIGMA, forming the ideal tool for measuring flatness and machines under work shop conditions. Furthermore the ENGINEER SET can be used for any levelling task or analysis of rotations.

The **ENGINEER SET** is specifically adapted to the needs of the metrology specialist taking care of machine tool components. There is a broad range of applications due to the possibility to use differential measurement. The system is universally applicable for inclination and for rotational measurements Thanks to its outstanding features and to the special transportation case the ENGINEER SET can be used in-house or be taken along to customers.

A2 DIFFERENCE BETWEEN THE CONFIGURATION WITH BLUEMETER SIGMA AND BLUETC

Basically two configurations are possible. The instruments as well as the display (BlueMETER SIGMA) or interface (BlueTC) components are available with or without radio transmission.

I. Communication from instrument to external display via cable.

This conventional type of communication uses cables between the various components (BlueMETER SIGMA, respectively BlueTC).

II. Communication from the instruments to the external display or to the interface via radio transmission.

Using this type of configuration the data transmission is by radio module between the instruments and the BlueMETER SIGMA or BlueTC. As a back-up system additional cables are also supplied.

Remarks:

For a surcharge it is possible to upgrade a set delivered with cables at a later stage to the radio transmission module.

Difference between **BlueMETER SIGMA** and **BlueTC**:

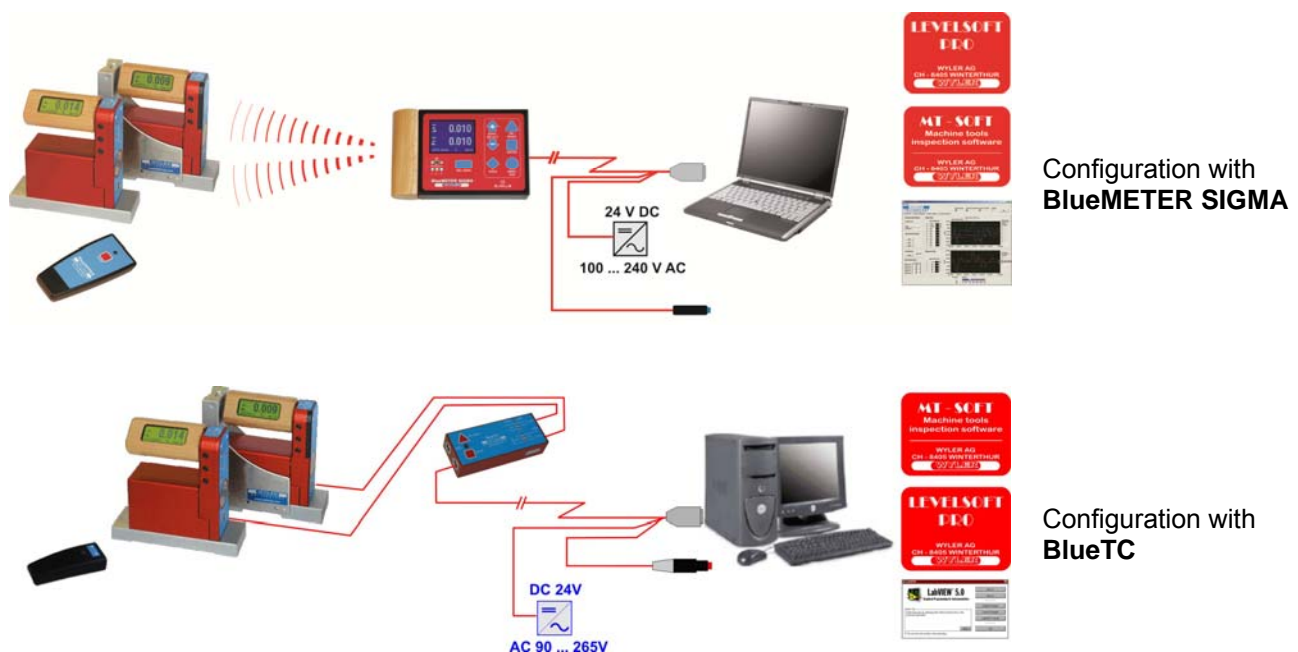

The functions of BlueMETER SIGMA and BlueTC are all the same with the exception of the LCD display which is only available with the BlueMETER SIGMA. When working without PC/Laptop it is not possible to display the difference between two instruments on the BlueTC. When working with a PC/Laptop and the software LEVELSOFT PRO or MT-SOFT the BlueTC is used as interface. The use of a BlueTC makes therefore only sense in combination with a PC/Laptop or when the difference between two instruments is not important to measure.

A3 INSTRUMENT'S OVERVIEW THE INSTRUMENTS OF THE BLUESYSTEM - FAMILY IN DETAIL

The following instruments are part of the BlueSYSTEM family



BlueLEVEL

The measuring instrument with different available sensitivities and integrated display of the values, the instrument's address and the measuring unit. The BlueLEVEL is available with or without radio module.



BlueMETER SIGMA

Display unit with various functions also serving as interface between PC/Laptop. The BlueMETER SIGMA is available with or without radio module.



BlueTC (Transceiver/Converter)

Interface with various functions used for element between instruments and PC/Laptop. The BlueTC is available with or without radio module. The BlueTC can also be used as a wireless transmission interface for other WYLER sensors.

Common features of all the BlueSYSTEM family instruments:

- One international standard in Bluetooth™ wireless technology if equipped with the radio modules
- All instruments are equipped with RS232 / RE422 / RS485 interfaces
- All instruments compatible to WyBus (RS485)
- All instruments working equivalently on the same level of communication

Features of the interfaces BlueMETER SIGMA and BlueTC:

- Both instruments can be used as interface between instruments and PC/Laptop
- Both instruments use identical functions for grouping instruments via radio module
- Both instruments use battery power
- All instruments are equipped with cable connections as alternative to radio transmission

Additional features available in the BlueMETER SIGMA:

- Additional functional keys for:
 - Choice of sensor connections A or B, A and B, A minus B
 - Refresh function in order to up-date the list of instruments
 - Install relative ZERO
 - <HOLD> Function, e.g. for "freezing" a measured value.
 - Display of the measured value of one or two instruments connected
 - Display of the difference between two connected instruments
 - Change of display unit used
 - Set various filter types

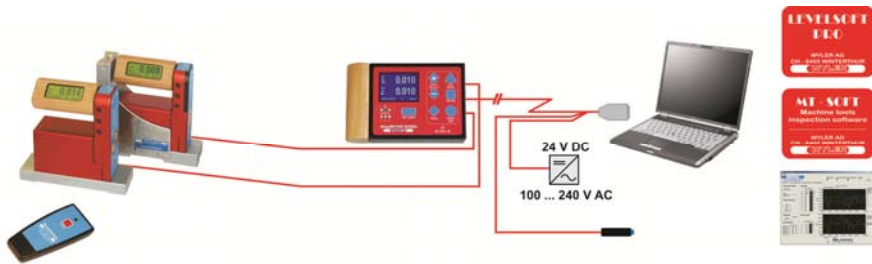

Data transmission via cables to PC/Laptop

Two BlueLEVEL with **BlueMETER SIGMA** and infrared-zapper for triggering the data transmission

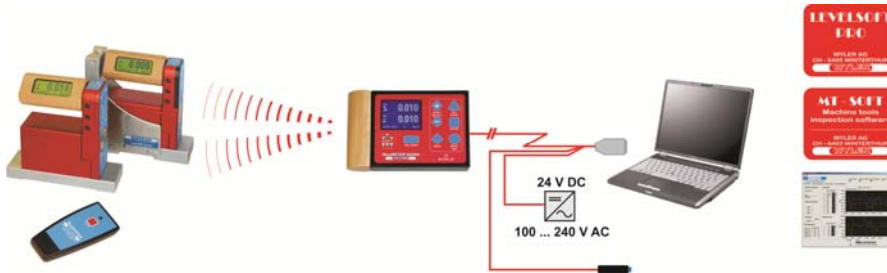

Wireless data transmission (Bluetooth™ wireless technology) and connection to PC / Laptop

Two BlueLEVEL with **BlueMETER SIGMA** and infrared-zapper for triggering the data transmission

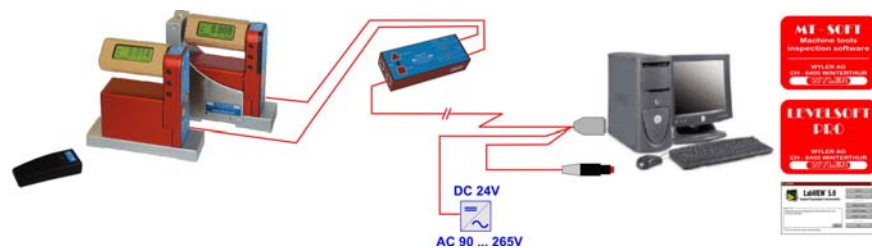

Data transmission via cables to PC/Laptop

Two BlueLEVEL with **BlueTC** and infrared-zapper for triggering the data transmission

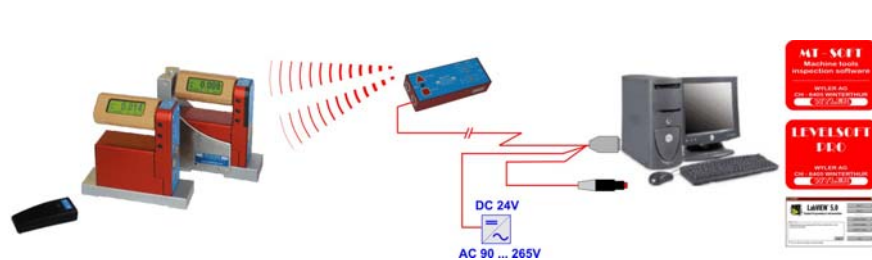

Wireless data transmission (Bluetooth™ wireless technology) and connection to PC / Laptop

Two BlueLEVEL with **BlueTC** and infrared-zapper for triggering the data transmission



According to the WyBus compatibility scheme even more than 2 sensors can be connected to a BlueMETER SIGMA respectively to a BlueTC. With connection via cables up to 63 sensors and with wireless data transmission up to 15 sensors are possible. One or two of sensors can be selected for display on the BlueMETER SIGMA at a time.

B EXAMPLE USING THE HYPER TERMINAL OF WINDOWS OR WINDOWS TERMINAL PROGRAM (EXAMPLE IS WIN XP)

1. Open the Terminal-Program in Windows / Accessories. and insert a name

Confirm with **<OK>**

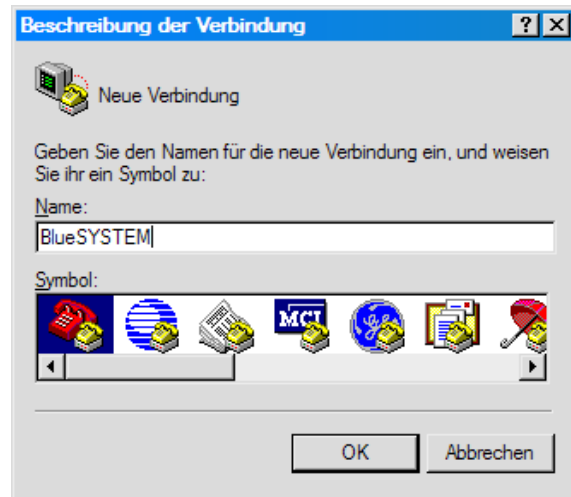

2. Enter the serial port definition connected to the BlueMETER SIGMA.

Confirm with **<OK>**



3. Enter the parameters

Bits per Second:	9600
Data bits:	7
Parity:	no
Stop bits:	2
Protocol:	no

Confirm with **<OK>**

The HyperTerminal-Windows appear.

Repeatedly pressing the key **<SEND/ESC>** the actual value will be transmitted in [Rad]

Alternatively the value can be called by pressing the key "P" on the PC keyboard.

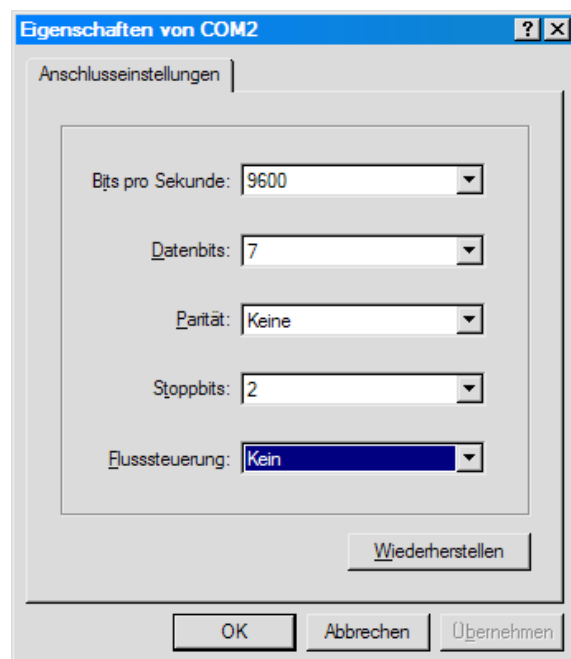

Example: Two BlueLEVELs and a BlueMETER SIGMA are connected

Remark:

The configuration has to be done first on the BlueMETER SIGMA

- 1 BlueLEVEL with the address H0200 is connected to Port "A"
- 1 BlueLEVEL with the address H0201 is connected to Port "B"
- Measuring-mode: Display of values instruments on Port "A" and "B" simultaneously

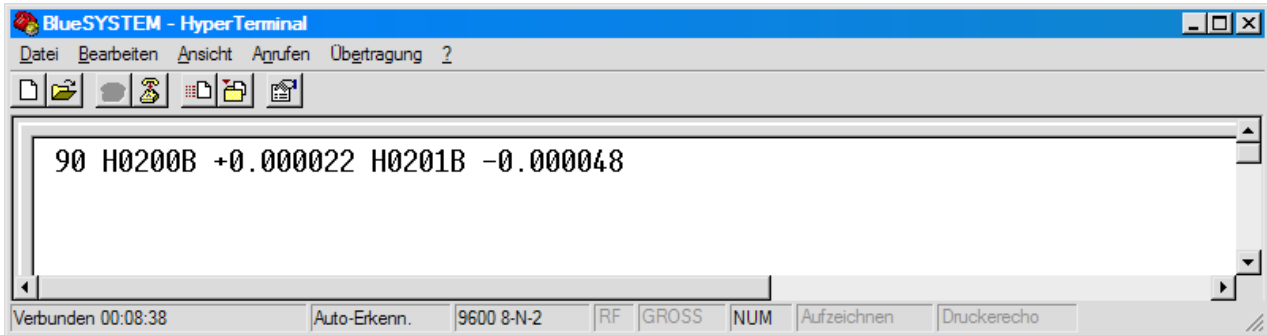

Meaning of the display:

090	Continuous number
H0200B	BlueLEVEL with the address H0200 is connected to Port "A"
+0.000022	+0.000022 Rad respectively +22 μ Rad
H0201B	BlueLEVEL with the address H0201 is connected to Port "A"
-0.000048	-0.000048 Rad respectively -48 μ Rad

C SPECIAL FUNCTIONS

C1 RESET TO FACTORY PRE-SETTINGS

You can reset all adjustments and settings to the factory pre-settings. For this action press simultaneously the keys <ENTER> and <ON/MODE> until an arrow to the right hand side appears in the display.

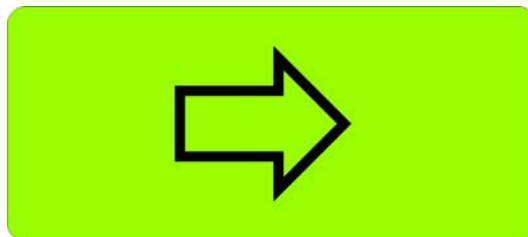

The following values will be set and the following actions performed:

BlueMETER SIGMA:

- Filter Type 3
- Unit mm/m
- Display mode Absolute
- Relative Base in millimetres, value 1000
- Relative Base in Inch, value 10
- All members of the wireless data transmission group are deleted
- All members of the list of instruments are deleted

BlueTC

- All members of the wireless data transmission group are deleted
- All members of the list of instruments are deleted

BlueLEVEL

- Filter Type 3
- Unit set to
 - 1 μ instrument: mm/m, 3 decimals
 - 5 μ instrument: mm/m, 3 decimals, rounded to 5 μ m/m
 - 10 μ instrument: mm/m, 2 decimals
- Display mode Absolute
- Relative Base in millimetre, value 1000
- Relative Base in Inch, value 10
- All members of the wireless data transmission group are deleted
- Relative Zero is set to 0
- Absolute Zero is set to 0

C2 FIRMWARE VERSION

With a special key operation you can read the version number of the firmware installed. After turning off the instrument hold the <ON/MODE> key down for another 10 seconds.

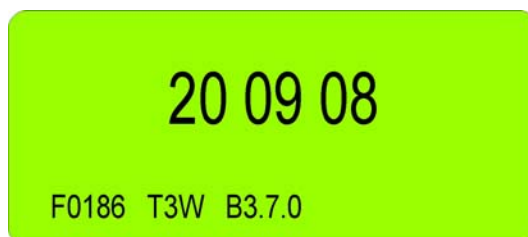

The display shows in large figures the date of issue and at the bottom the version number of the firmware.

C3 ACTIVATE THE FUNCTION KEY ON THE BLUETC

In the basic state the function keys of the BlueTC are locked. Using the following key combination you can enable the function keys:

- Hold the key <ENTER> down
- After approx. 3 seconds press additionally the key <ON/MODE>
- Hold both keys down for another 3 seconds
- Release both keys at the same time

With repeated action of the key <ON/MODE> you can select the menu required.
Confirmation with the key <ENTER> will execute the respective menu.

The key lock function is disabled until a function has been completed or until the BlueTC has been restarted. After that the key lock is active again.

D TECHNICAL DATA BLUESYSTEM
D1 TECHNICAL DATA OF THE RADIO MODULES

SENDER / RECEIVER	Frequency	ISM-Band / 2,4000 - 2,4835 GHz
BlueSYSTEM with Bluetooth® wireless technology	Modulation	FHSS (Frequency Hopping Spread Spectrum)
	Used Net-structure	Point to point / Point to multi-point
	RF Output power	Max. +17 dBm / Class 1
	Sensitive level Receiver	-80 dBm
	Batteries BlueLEVEL / BlueTC Batteries BlueMETER SIGMA	2 x 1.5V, Size "C" Alkaline 3 x 1.5V, Size "C" Alkaline

D2 TECHNICAL DATA OF THE BLUELEVEL

Sensitivity / Empfindlichkeit	1 µm/m 0.2 Arcsec	5 µm/m 1 Arcsec	10 µm/m 2 Arcsec
Display range / Anzeigebereich	± 20 mm/m	± 100 mm/m	± 200 mm/m
Limits of error / Fehlergrenze <0.5 Full-scale (DIN 2276)	max. 1% of measured value / max. 1% des aktuellen Messwertes		
Limits of error / Fehlergrenze >0.5<Full-scale (DIN 2276)	max. 1% of (2 x measured value - 0.5 x Full-scale) / max. 1% von (2 x aktueller Messwert - 0.5 x Messbereichsendwert)		
Temperature error / °C (Ø10°C) / DIN 2276	up to / bis 2000 µm/m: max. 2 µm/m	up to / bis 10000 µm/m: max. 10 µm/m	up to / bis 20000 µm/m: max. 20 µm/m
Temperaturkoeffizient / °C (Ø10°C) / DIN 2276	up to bis 20000 µm/m: max 20 µm/m	up to bis 100000 µm/m: max 100 µm/m	up to bis 200000 µm/m: max 200 µm/m
Display available / Anzeige verfügbar	within 3 seconds / innerhalb von 3 Sekunden		
Digital output / Digitalausgang	RS232 / RS422 / RS485, asynchron, 7 DataBits, 2 StopBits, no parity, 9600 bps		
External power supply Externe Stromversorgung	BlueLEVEL:	+ 5 V DC, max. 450 mW	
Operating temperature range / Betriebstemperatur	0 ... +40°C		
Storage temperature range / Lagertemperatur	-20 ... +70°C		
Net weight without measuring base, including batteries and handle Netto-Gewicht ohne Messbasis, inklusive Batterien und Griff	BlueLEVEL: 1200g		

D3 TECHNICAL DATA OF THE BLUEMETER SIGMA

Digital output / Digitalausgang	RS232 / RS485, asynchron, 7 DataBits, 2 StopBits, no parity, 9600 bps
External power supply Externe Stromversorgung	BlueMETER SIGMA: + 5V DC, max. 1 W or/oder 10...28 V DC
Operating temperature range / Betriebstemperatur	0 ... +40°C
Storage temperature range / Lagertemperatur	-10 ... +60°C
Net weight, including batteries Netto-Gewicht, inklusive Batterien	850g
Digital output / Digitalausgang	RS232 / RS485, asynchron, 7 DataBits, 2 StopBits, no parity, 9600 bps

D4 TECHNICAL DATA OF THE INTERFACES BLUETC

Sensitivity / Empfindlichkeit	-----	-----	-----
Digital output / Digitalausgang	RS232 / RS422 / RS485, asynchron, 7 DataBits, 2 StopBits, no parity, 9600 bps		
External power supply Externe Stromversorgung	BlueTC: + 5V DC, max. 450 mW or/oder 8...28 V DC		
Operating temperature range / Betriebstemperatur	0 ... +40°C		
Storage temperature range / Lagertemperatur	-20 ... +70°C		
Net weight without battery pack	150g		
Net weight, incl. battery-pack and incl. batteries	550g		
Netto-Gewicht ohne Batterie-Pack	150g		
Netto-Gewicht, inkl. Batterie-Pack und inkl. Batterien	550g		

D5 PIN-ASSIGNMENT BLUELEVEL, BLUEMETER SIGMA UND BLUETC (PIN-BELEGUNG)

D5.1 PORT A AND PORT B

RS232 / RS485
 Binder Serie 712
 8 pol.
 (female)

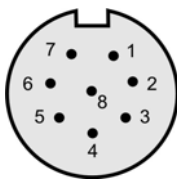

RS485

Connection	Signal	Pin Type	Pin Function
1	VPP	Power in	Unregulated Power
2	VSS	GND	Ground
3	VDD	Power out	Power +5V
4	RTA	Input/Output	RS485-Line A
5	RTB	Input/Output	RS485-Line B
6	-	-	-
7	-	-	-
8	KEY*	Input	Trigger Key

D5.2 OUT-PORT

RS232 / RS485
 Binder Serie 712
 8 pol.
 (female)

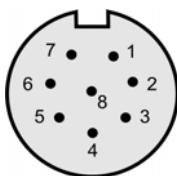

RS485

Connection	Signal	Pin Type	Pin Function
1	VPP	Power in	Unregulated Power
2	VSS	GND	Ground
3	VDD	Power out	Power +5V
4	RTA	Input/Output	RS485-Line A
5	RTB	Input/Output	RS485-Line B
6	-	-	-
7	-	-	-
8	KEY*	Input	Trigger Key

RS232

Connection	Signal	Pin Type	Pin Function
1	VPP	Power in	Unregulated Power
2	VSS	GND	Ground
3	VDD	Power out	Power +5V
4	TD	Output	RS232-TD
5	-	-	-
6	RD	Input	RS232-RD
7	-	-	-
8	KEY*	Input	Trigger Key

E SERVICE AND REPAIR

E1 REPAIR OF MEASURING INSTRUMENTS AND DISPLAY UNITS

Normally any instruments requiring repair can be sent to the local WYLER partner (local distributor) who will take the necessary steps and make the arrangements for repair on behalf of the customer.

Express Repair Service, ERS

A large number of customers can not miss the instruments for a longer period as these are in daily operation. For these cases WYLER SWITZERLAND has created a new service called "Express Repair Service, ERS". Employing this service the transport time from the user to WYLER SWITZERLAND and back and thus the complete repair time can be reduced considerably.



A simplified description of this service:

- The customer announces the repair request to the local WYLER partner in his country.
- The WYLER partner will inform the customer about the possibility of the ERS service outlining the advantages and consequences of this service, such as e.g.
 - reduced total repair time
 - required acceptance to repair without quote up to 65 % of the price for a new instrument
 - suitable packing for air transport
 - expenses of the ERS
- In case the customer decides to use the ERS, the customer informs the local WYLER partner or directly WYLER SWITZERLAND providing the necessary data.
- The customer will receive all information and instructions necessary for a smooth handling, the customer has just to pack the product suitably and to fill in a form for the **TNT courier service** as well as to announce the readiness to the local TNT office for pick-up. Everything else will run automatically.
- Products reaching WYLER SWITZERLAND under this service will be handled with **first priority, and** the instrument will be returned using the same carrier.
- The invoicing will be through the WYLER partner in your country.

Please do not hesitate to make use of this service in order to have your WYLER instrument back at your disposal as soon as possible. In case of any questions please contact WYLER SWITZERLAND or your local distributor, we will gladly help you to use the ERS successfully.

E2 SERVICE- AND MAINTENANCE CONTRACTS

Measuring systems are becoming more and more complex and are therefore subject to continuous supervision in respect of quality and reliability. For this purpose WYLER AG offers the option of a **MAINTENANCE CONTRACT** with the purchase of new instruments.

Such a MAINTENANCE CONTRACT offers the following services to the customer:

- Complete **inspection and re-adjustment** of the instrument / system in a bi-yearly interval.
- The scope of delivery includes an **internationally recognised Calibration Certificate SCS** for the entire system confirming the performance after the service intervention. Traceable certificates SCS are issued according to our accreditation as a calibration laboratory by the Swiss authorities
- **Highest priority for any repair works** (actual repair work is not included and will be quoted separately)
- **Technical enhancements and modifications** published by WYLER, if considered suitable
- **Costs for packing and transport** of the instrument(s) from the customer to WYLER and back, either directly or through the WYLER distribution partner
- **Extension of warranty period to 24 months**: If a maintenance contract is signed within 6 months of the purchasing of a new instrument the warranty period is extended to 24 month.



Options:

Depending on the customers requirement the re-calibration interval can be shortened (every year) or be extended (every 3rd year)

The following services are **excluded** from all maintenance contracts:

- The contract does not include any repair work. If it is determined during the inspection or the re-calibration process that the instrument requires repair, such work will be quoted separately to the customer.

**We help you to keep your valuable and important instruments always accurate and ready for use!
We would be glad to offer you a maintenance contract adapted to your specific requirements.**

F STORAGE OF THE INSTRUMENTS / CARE AND HANDLING OF THE BATTERIES

F1 STORAGE OF THE INSTRUMENTS

For storage periods the measuring instrument should be placed in a position in which the instruments are also used when measuring (upright position). Unsuitable storage may result in a longer period of zero creeping due to overload of the pendulum system.

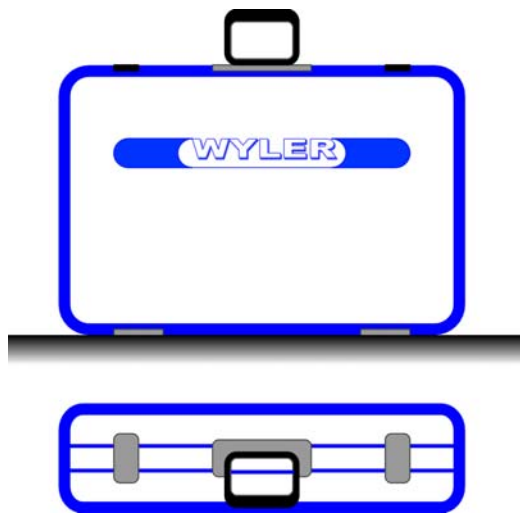
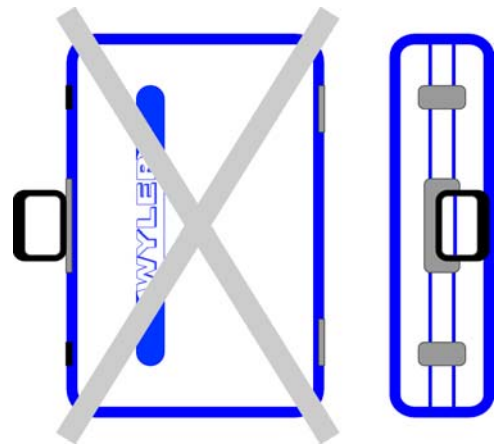

FIG. 14



F2 CARE AND HANDLING OF THE BATTERIES

BATTERY REPLACEMENT

BlueLEVEL: 2 pieces 1.5V, Size "C" ALKALINE

BlueMETER SIGMA: 3 pieces 1.5V, Size "C" ALKALINE

BlueTC: 2pieces 1.5V, Size "C" ALKALINE

Read the instructions in your manual before installing batteries. Make sure to insert the batteries properly, following the symbols showing you the correct way to position the positive (+) and negative (-) ends of the batteries. Keep battery contact surfaces clean by gently rubbing with a clean pencil eraser or cloth. Replace batteries with the size and type specified by the device's manufacturer. Remove all used batteries from the device at the same time, then replace them with new batteries of the same size and type. Store batteries in a cool, dry place at normal room temperature. Remove batteries from devices that will be stored for extended periods. Don't dispose of batteries in a fire - they may rupture or leak. Don't recharge a battery unless it is specifically marked "rechargeable." Attempting to recharge a normal battery could result in rupture or leakage.

Disposal of Batteries / Accumulators

You are required by law (Battery Ordinance) to return all spent batteries/accumulators. Disposing of spent batteries/accumulators in the household waste is prohibited!

Batteries / accumulators that contain hazardous substances are marked with the symbols on the side. These symbols indicate that it is prohibited to dispose of these batteries in the household waste.



You can return spent batteries respectively accumulators that can no longer be charged free of charge to the collection points in your community, our outlets or everywhere else where batteries or accumulators are sold.

You thus fulfil the legal requirements and contribute to the protection of our environment!

G ACCREDITATION BLUETOOTH™ WIRELESS TECHNOLOGY FOR BLUESYSTEM
G1 MANUFACTURERS DECLARATION OF CONFORMITY (DoC)

We,

Name: WYLER AG
Im Hoelderli
CH-8405 Winterthur / Switzerland
Telephone: +41 52 233 66 66
Fax: +41 52 233 20 53
Homepage: <http://www.wylerag.com>
E-Mail: wyler@wylerag.com

declare under our sole responsibility, that the Products:

Inclination Measuring System "Engineer set BlueSYSTEM" with Bluetooth™ wireless technology, consisting of

- BlueSYSTEM-Set No. 020Fxxx-yyy-0zz
- BlueLEVEL No. 016Fxxx-yyy-sss
- BlueMETER SIGMA No. 016F004-001
- BlueTC No. 016-003-001-F

The letter "F" indicates: with integrated Bluetooth-Module

to which this declaration relates is in conformity with the essential requirements and other relevant requirements of the R&TTE Directive 1999/5/EC.

The products comply with the following standards and other normative documents:

RF: EN 300 328-2 V1.1.1 (2000-07)
Low Voltage Directive: 73/23/EEC "safety"
EN 60950, EN 61131-2 (radio)
IEC 60601-1-2 medical electrical equipment (radio)
EN 61010-1 (BlueSYSTEM)
EMC 89/336/EEC: EN 61000-6-3: 2001 emission
EN 61000-6-1 : 2001 immunity
(generic standard, household and light industrial environment)
EN 61000-6-4: 2001 emission
EN 61000-6-2 : 2001 immunity
(generic standard, industrial environment)
EN 301 489-1 V1.3.1: (2001-09)
EN 301 489-17 V1.1.1: (2000-09)

For information: On the base of this DoC, the products will bear following mark:



Place & Date of issue:
CH-Winterthur, 01.07.2005

Signed by the manufacturer:
Mr. H. E. Hinnen

Title: Managing Director Engineering / R&D

G2 BLUETOOTH EQUIPMENT

BlueSYSTEM-Instruments are equipped with OEM Serial Port Adapter 33i, 2nd Generation
With Bluetooth™ wireless technology

Manufacturer: connectBlue AB
Stora Varvsgatan 11 N:1
SE-211 19 Malmö, Sweden



Product Name: OEM SPA33i, with internal antenna (SMD-Type)

OEM Module ID: **cB-0702-01**
Type: BT-Class 1 / max. +20dBm
RF-Output Power : < 16dBm/100kHz e.i.r.p.
Antenna: integral (SMD)
Qualified Bluetooth Product, with
Bluetooth ID: B00931
QPN: GRA_001_03.pdf

G3 FCC COMPLIANCE

FCC Statement for cB-0702-02

This device contains
FCC ID: **PVH070201**

This device complies with Part 15 of the FCC Rules. Operation is subject to the following two conditions: (1) this device may not cause harmful interference, and (2) this device must accept any interference received, including interference that may cause undesired operation.

NOTE:

This equipment has been tested and found to comply with the limits for a Class B digital device, pursuant to Part 15 of the FCC Rules. These limits are designed to provide reasonable protection against harmful interference in residential installation. This equipment generates, uses and can radiate radio frequency energy and, if not installed and used in accordance with the instructions, may cause harmful interference to radio communications. However, there is no guarantee that interference will not occur in a particular installation. If this equipment does cause harmful interference to radio or televisions reception, which can be determined by turning the equipment off and on, the user is encouraged to try to correct the interference by one or more of the following measures:

- Reorient or relocate the receiving antenna
- Increase the separation between the equipment and receiver
- Connect the equipment into an outlet on a circuit different from that to which the receiver is connected
- Consult the dealer or an experienced radio/TV technician for help

G4 COUNTRY SPECIFIC INFORMATION FOR BLUETOOTH RADIO LINK (>10MW RF-POWER)

List of European Countries with Notification, without Restrictions:

GENERAL	Hereby, Wyler AG, CH-8405 WINTERTHUR, declares that "BlueSYSTEM" and its components (2.400 - 2.4835 GHz) are in compliance with the essential requirements and other relevant provisions of Directive 1999/5/EC.
GB	Hereby, Wyler AG, CH-8405 WINTERTHUR, declares that "BlueSYSTEM" and its components (2.400 - 2.4835 GHz) are in compliance with the essential requirements and other relevant provisions of Directive 1999/5/EC.
NL	Hierbij verklaart Wyler AG, CH-8405 WINTERTHUR dat "BlueSYSTEM" en zijn componenten (2.400 - 2.4835 GHz) in overeenstemming zijn met de essentiële eisen en de andere relevante bepalingen van richtlijn 1999/5/EG.
SE	Härmed intygar Wyler AG, CH-8405 WINTERTHUR att "BlueSYSTEM" och deras komponenter (2.400 - 2.4835 GHz) stämmer överens med de väsentliga egenskapskrav och övriga relevanta bestämmelser som framgår av direktiv 1999/5/EG.
DE	Hiermit erklärt Wyler AG, CH-8405 WINTERTHUR, dass sich "BlueSYSTEM" und seine Geräte (2.400 - 2.4835 GHz) in Übereinstimmung mit den grundlegenden Anforderungen und den anderen relevanten Vorschriften der Richtlinie 1999/5/EG befinden.
CZ	Tímto firma Wyler AG, CH-8405 Winterthur, deklaruje, že " BlueSYSTEM" a jeho součásti, jsou v souladu s nezbytnými požadavky a s ostatními příslušnými podmínkami směrnice 1999/5/EC.
CH	Hiermit erklärt Wyler AG, CH-8405 WINTERTHUR, dass sich "BlueSYSTEM" und seine Geräte (2.400 - 2.4835 GHz) in Übereinstimmung mit den grundlegenden Anforderungen und den anderen relevanten Vorschriften der Richtlinie 1999/5/EG befinden.
NO	Herved erklærer Wyler AG, CH-8405 WINTERTHUR, at „BlueSYSTEM“ og deres komponenter (2.400 - 2.4835 GHz) stemmer overens med de vesentlige egenskapskrav og øvrige relevante bestemmelser som fremgår av direktiv 1999/5/EG.



List of European Countries with Notification, with Restrictions:

FR	<p>Par la présente Wyler AG, CH-8405 WINTERTOUR déclare que les instruments "BlueSYSTEM et ses composants (2.400 - 2.4835 GHz) sont conforme aux exigences essentielles et aux autres dispositions pertinentes de la directive 1999/5/CE.</p> <p>Attention: En France (07/2005) les contraintes géographiques sont a respecter : L'utilisation de l'équipement bluetooth (>10mW) à l'extérieur des bâtiments sur le domaine public n'est pas possible</p> <p>Attention: In France (07/2005) the geographic restrictions must be respected. The use of Bluetooth™ equipment (>10 mW) outside of buildings in the public domain is not possible.</p>
-----------	--

IT	<p>Con la presente Wyler AG, CH-8405 WINTERTHUR dichiara che questo instrumenti "BlueSYSTEM" (2.400 - 2.4835 GHz) sono conforme ai requisiti essenziali ed alle altre disposizioni pertinenti stabilite dalla direttiva 1999/5/CE.</p> <p>Attenzione: In Italia (07/2005) vanno osservate le limitazioni geografiche : L'equipaggiamento deve essere utilizzato solo all'interno dell'edificio / dell'area aziendale.</p> <p>Attention: In Italy (07/2005) the geographic restrictions must be respected. Bluetooth™ equipment must be used inside of buildings / factory areas only.</p>
-----------	---



List of Countries with notification:

JPN	<p>Hereby, Obishi Co., Ltd, JP-940-1164 Nagaoka-City Niigata, declares that "BlueSYSTEM" and its components (2.400 - 2.4835 GHz) are in compliance with the essential requirements and other relevant provisions of ARIB Standard – T66, Version 2.1.</p>
------------	---

List of Countries with pending Notification:

- Russia
- Canada
- China
- Taiwan
- South Korea
- India
- Thailand
- Australia

H FLOWCHARTS
H1 POWER UP (BLUEMETER SIGMA ONLY)

POWER UP / Gerät einschalten

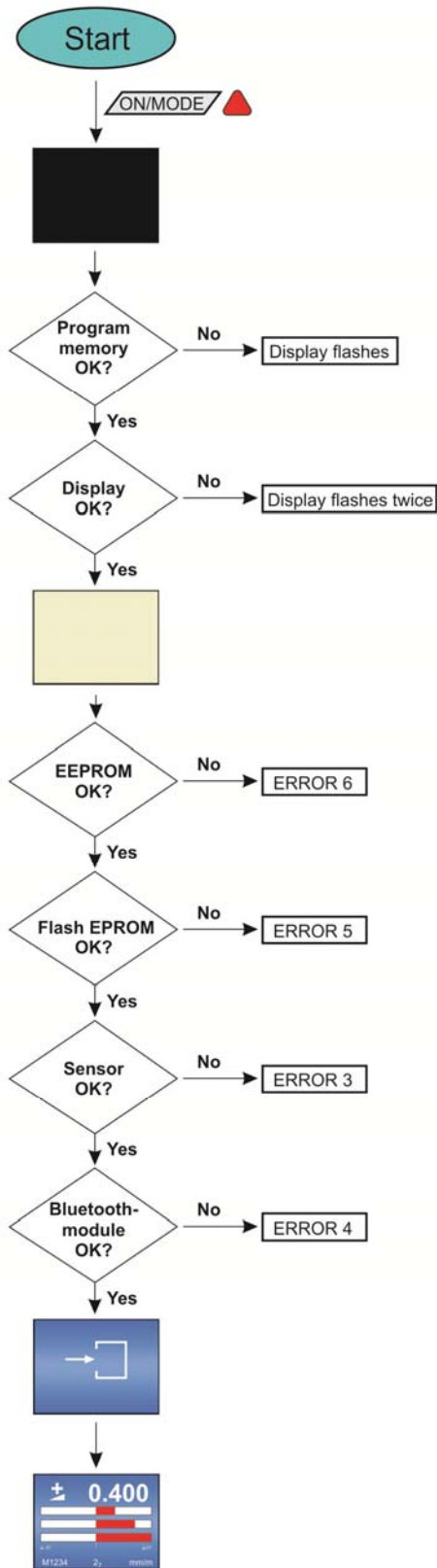

Relative ZERO Key

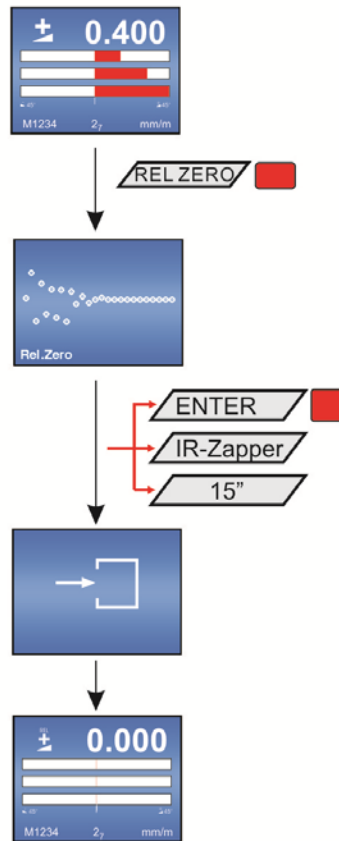

H3 KEY HOLD, FREEZING OF A MEASURING VALUE / HOLD

HOLD

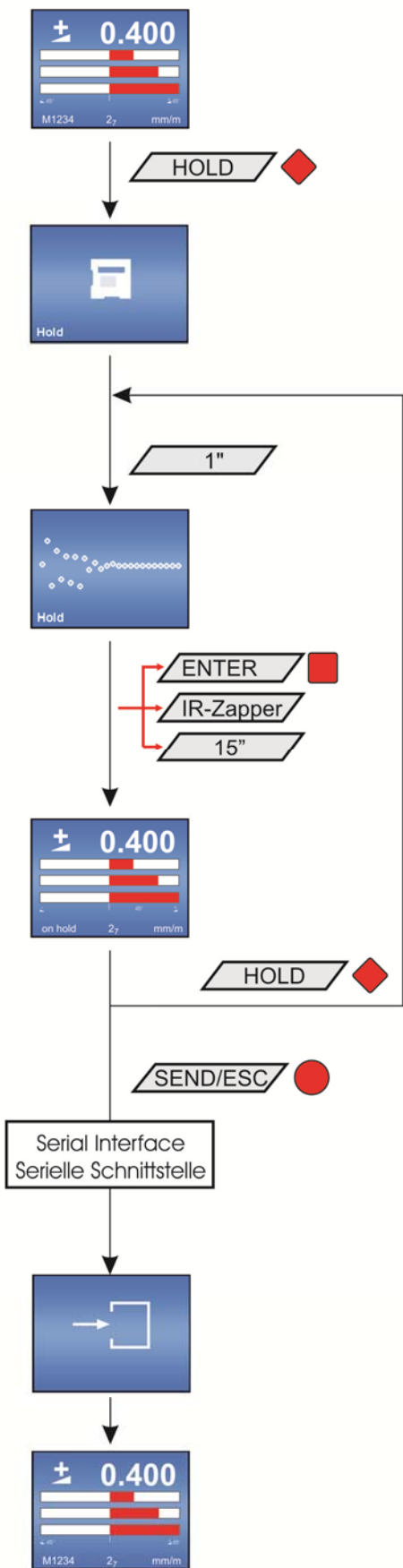

H4 MENU SELECTION/ MODE

Menu selection

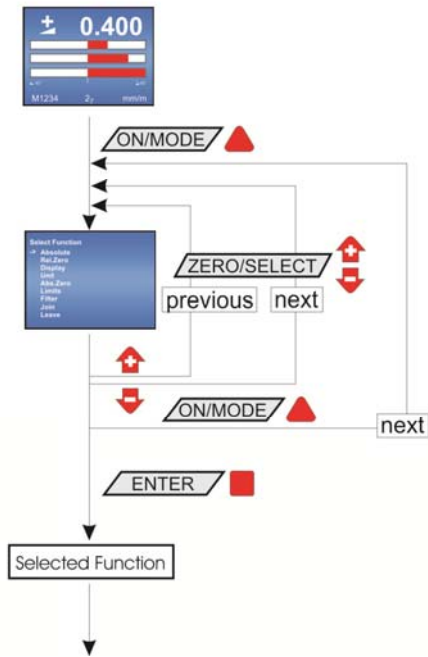

H5 ADJUSTMENT OF THE DISPLAY / DISPLAY

DISPLAY

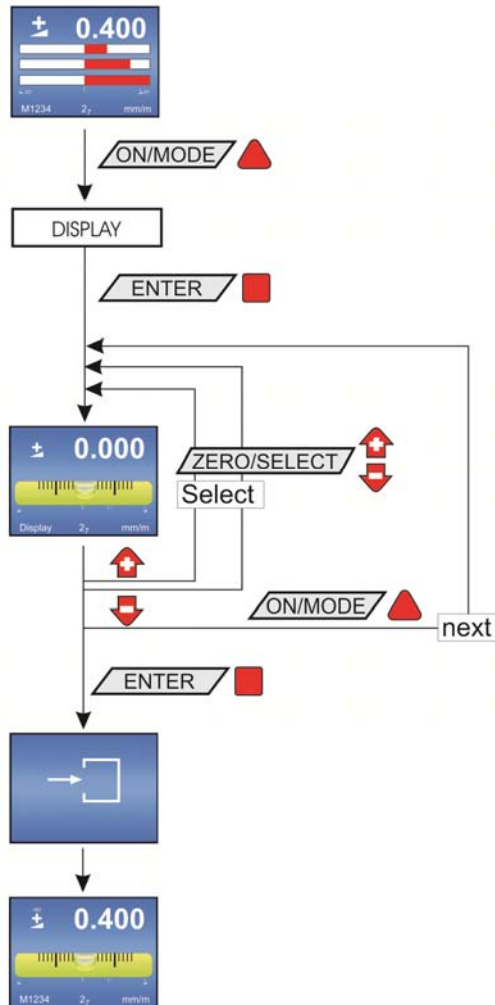

Absolute

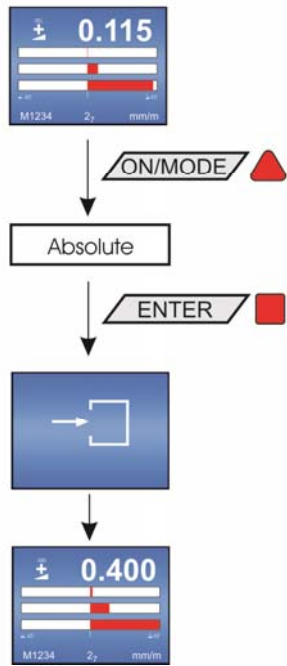

H7 MEASURING ABSOLUTE CONSIDERING THE ZERO OFFSET / MODE **ABSOLUTE ZERO**

Absolute ZERO

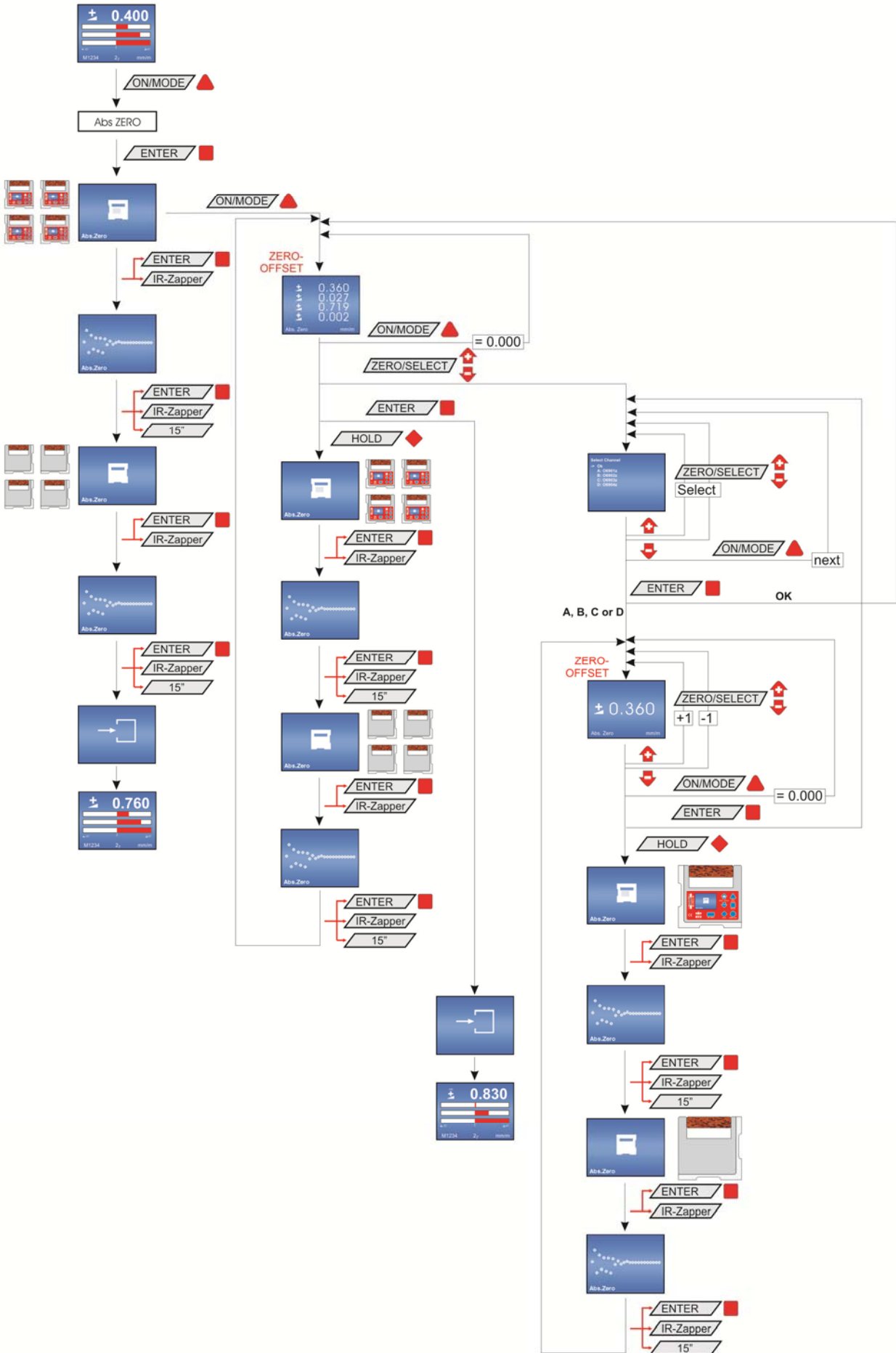

Relative ZERO

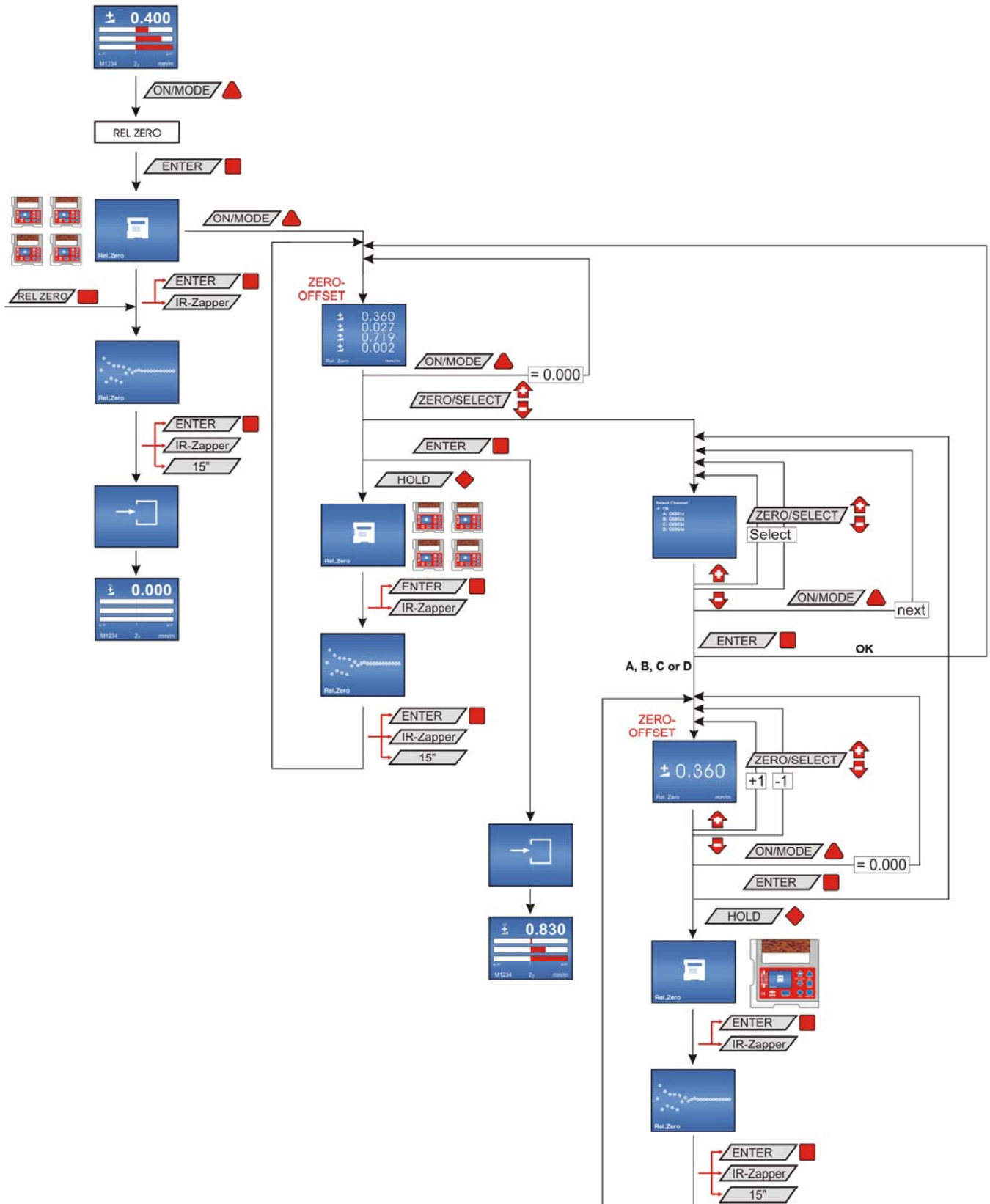

H9 ADJUSTMENT OF THE MEASURING UNIT / UNIT

UNIT

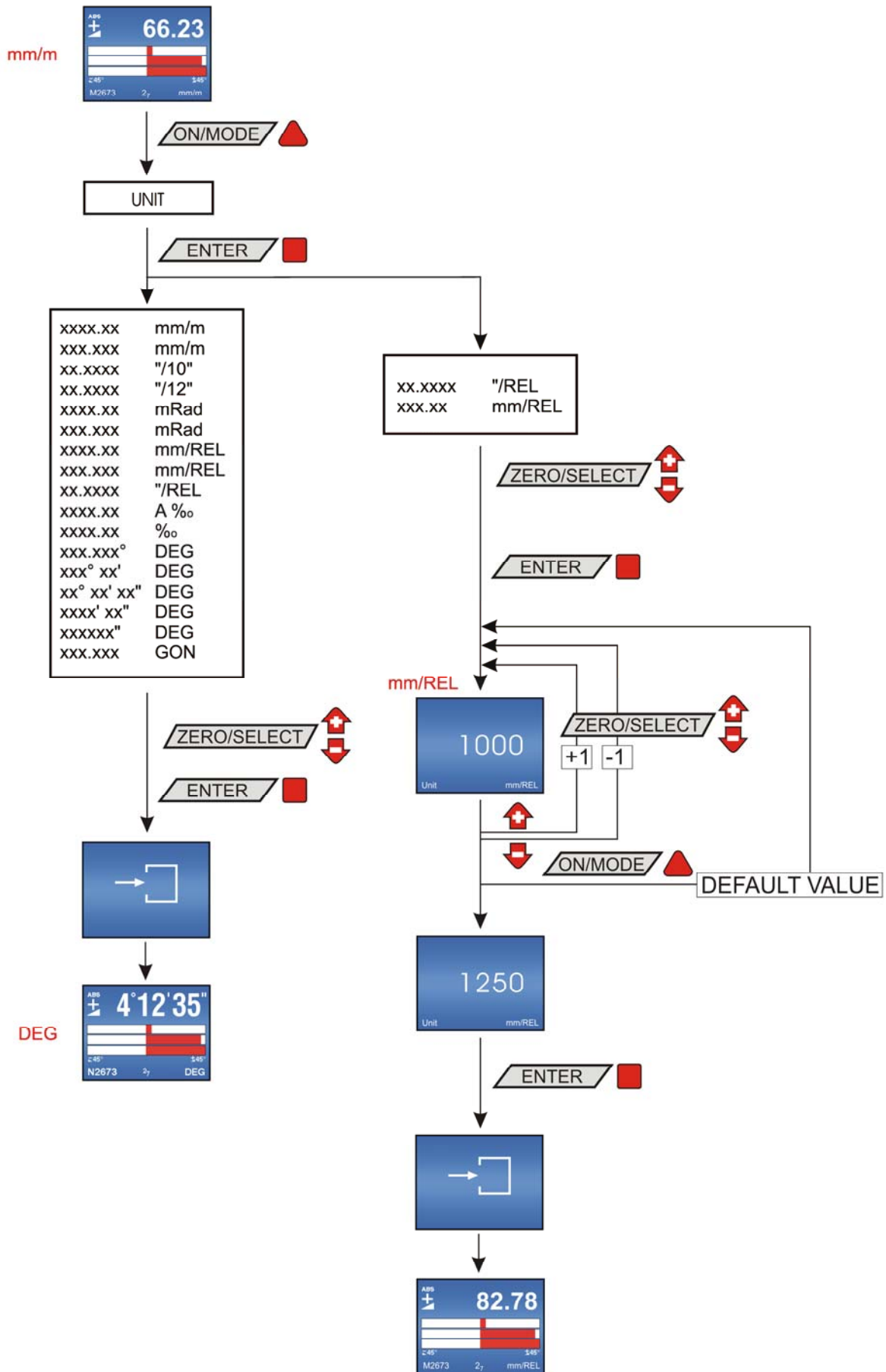

LIMITS

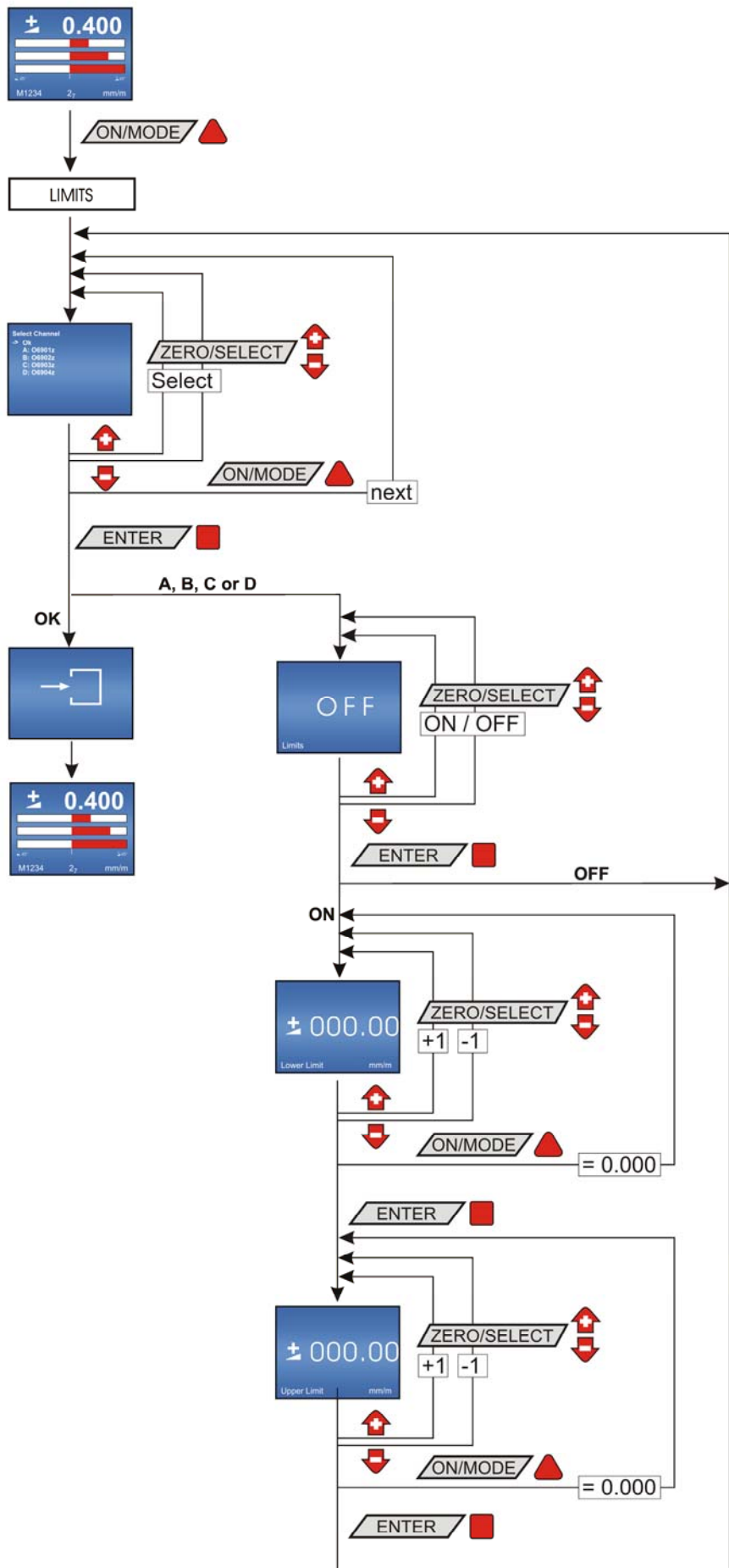

FILTER

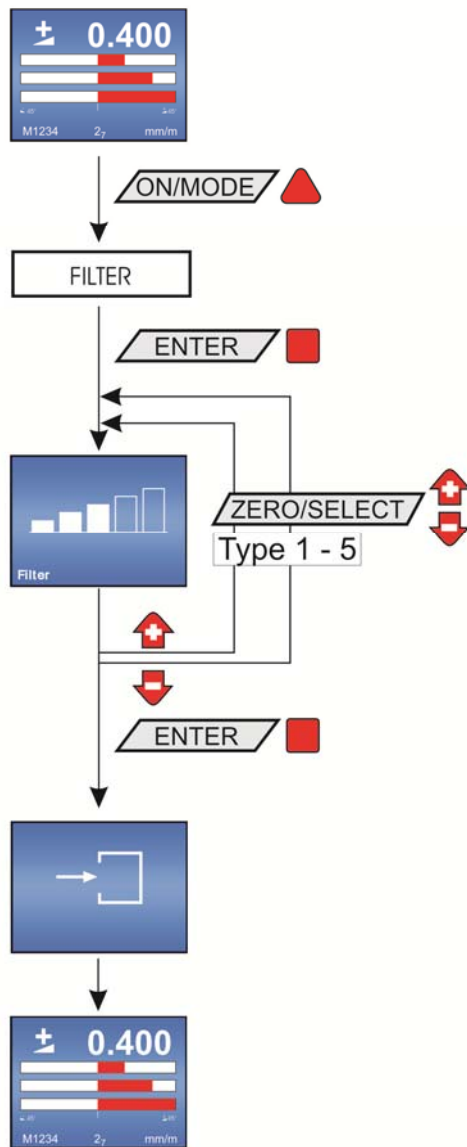

JOIN

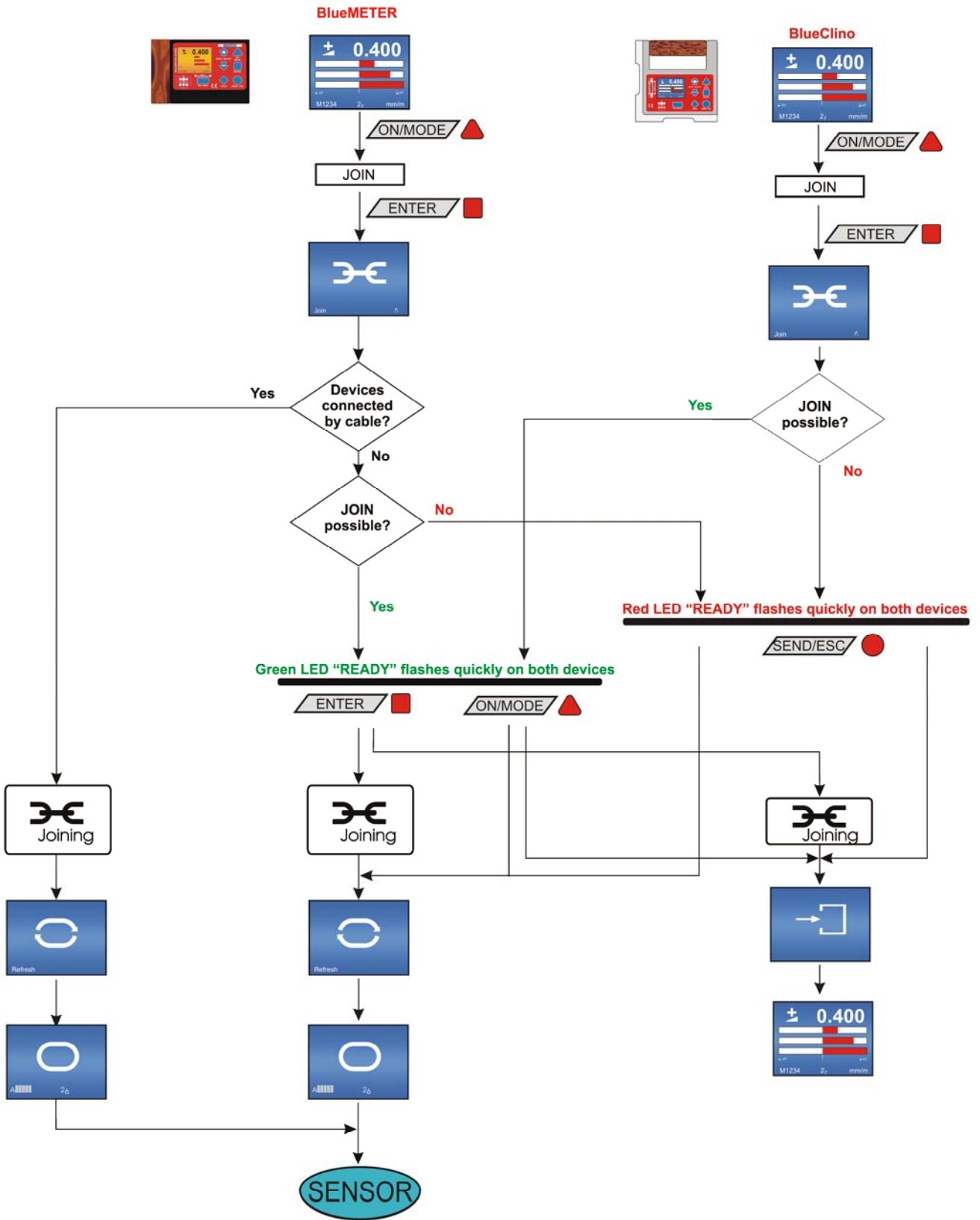

H13 LEAVING A GROUP OF INSTRUMENTS / LEAVE

LEAVE

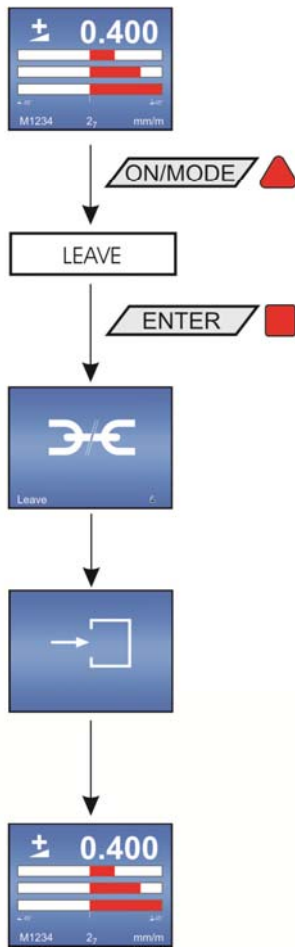

I FLOAT CHARTS OPTIONS

I1 PIN-CODE-QUERY FOR ACCESS TO THE OPTIONS

OPTIONS / PIN-Code query

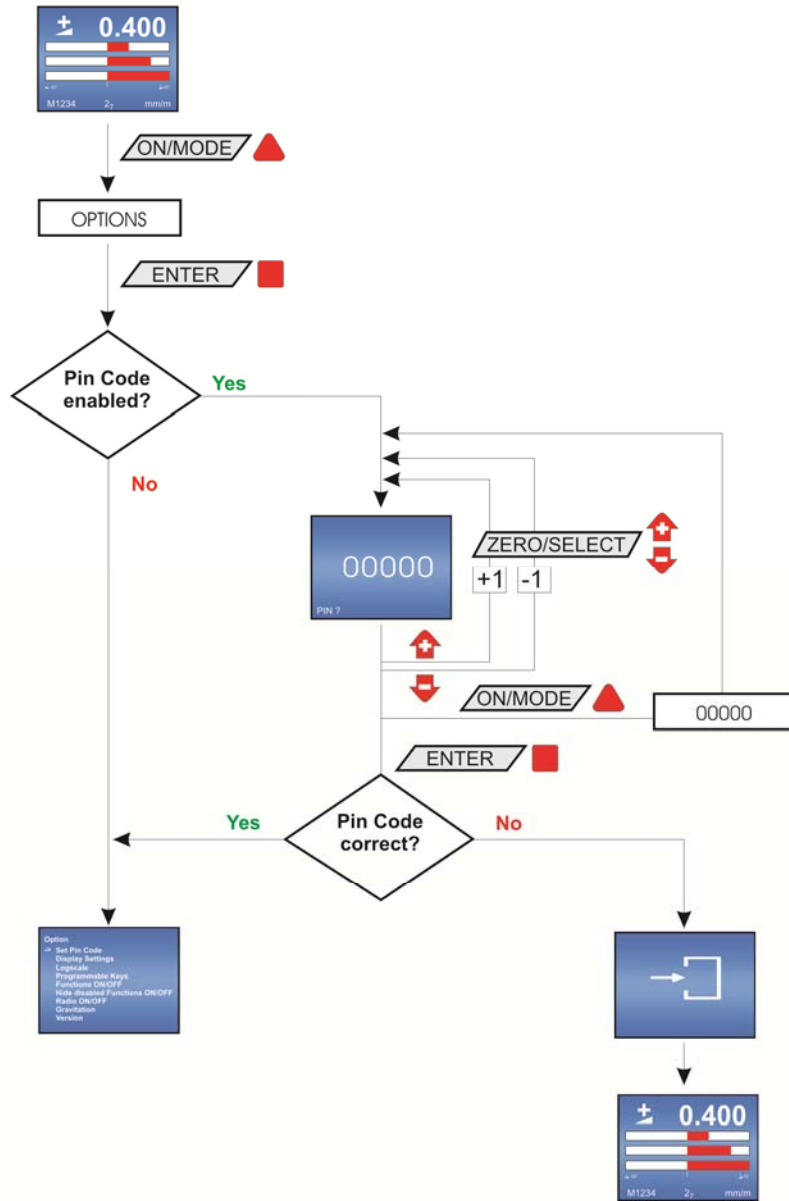

OPTIONS / Set Pin-Code

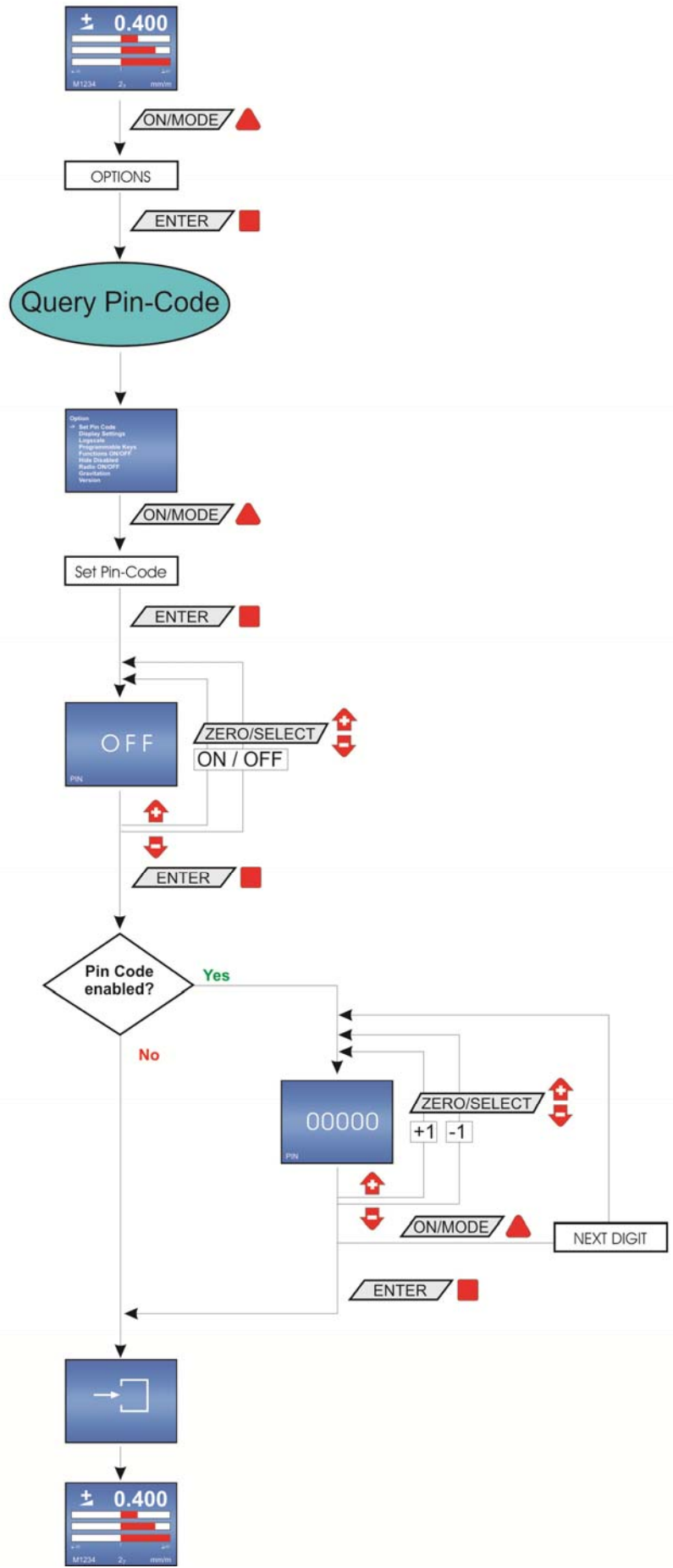

OPTIONS / Display Settings

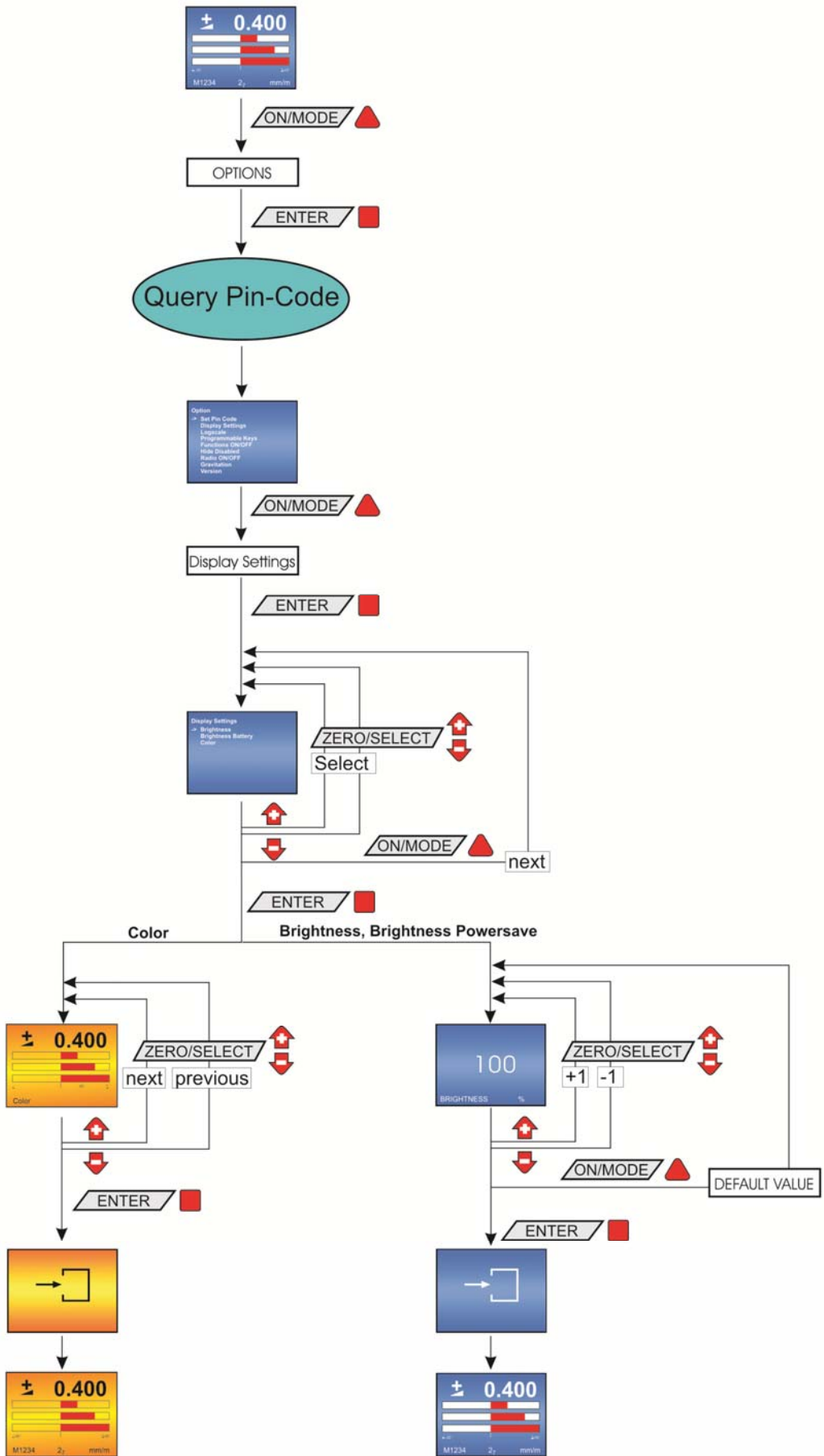

OPTIONS / Logarithmic Scale ON/OFF

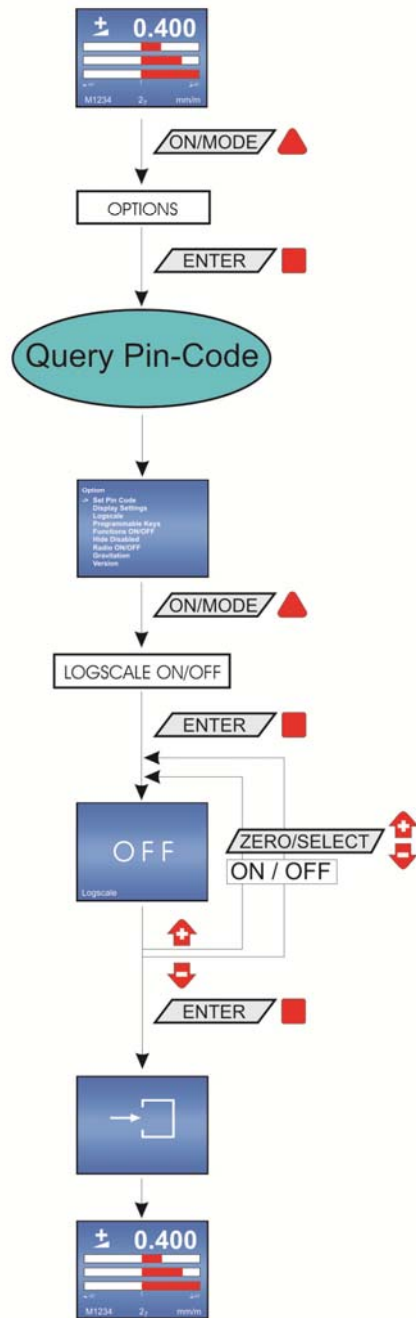

OPTIONS / Programmable Keys

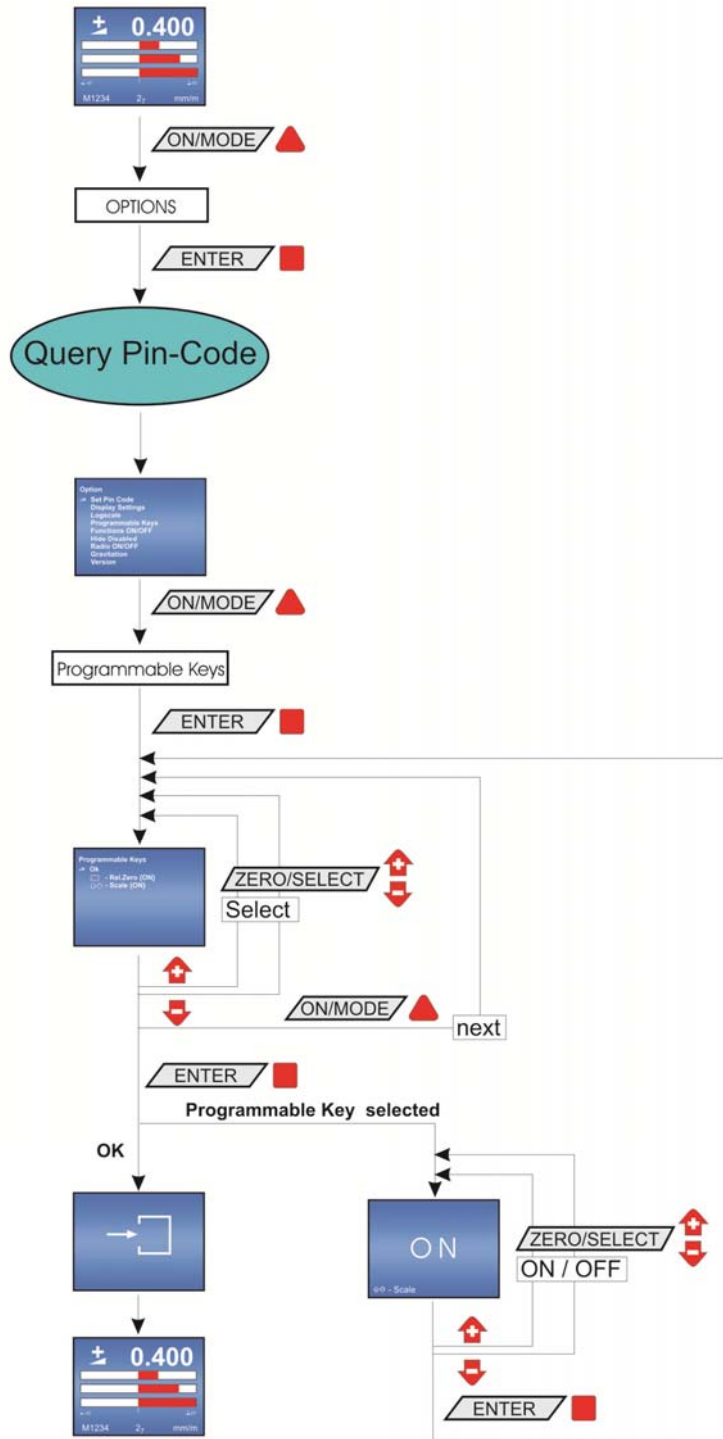

OPTIONS / Functions ON/OFF

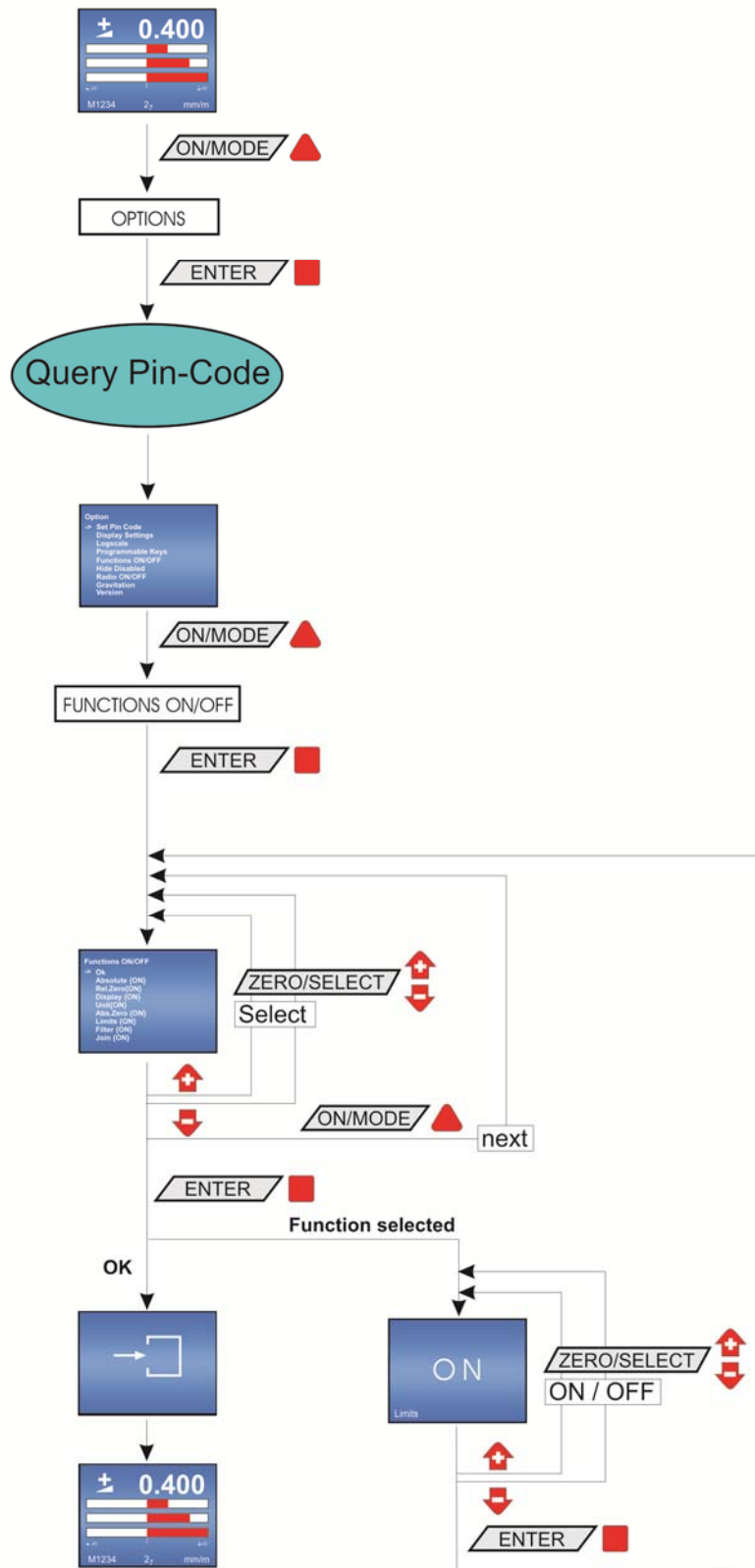

OPTIONS / Hide disabled Functions

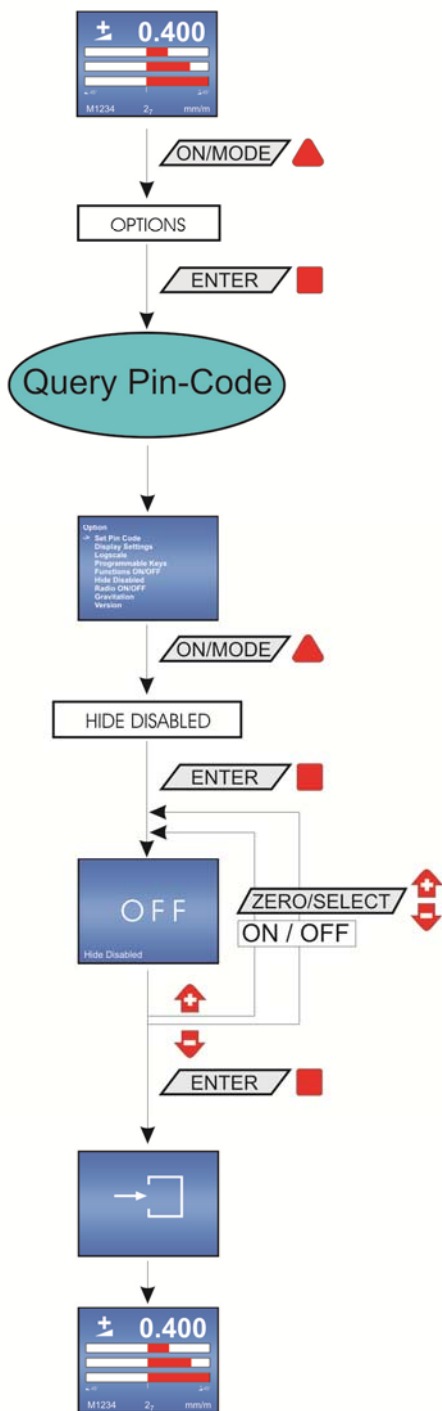

OPTIONS / Radio ON/OFF

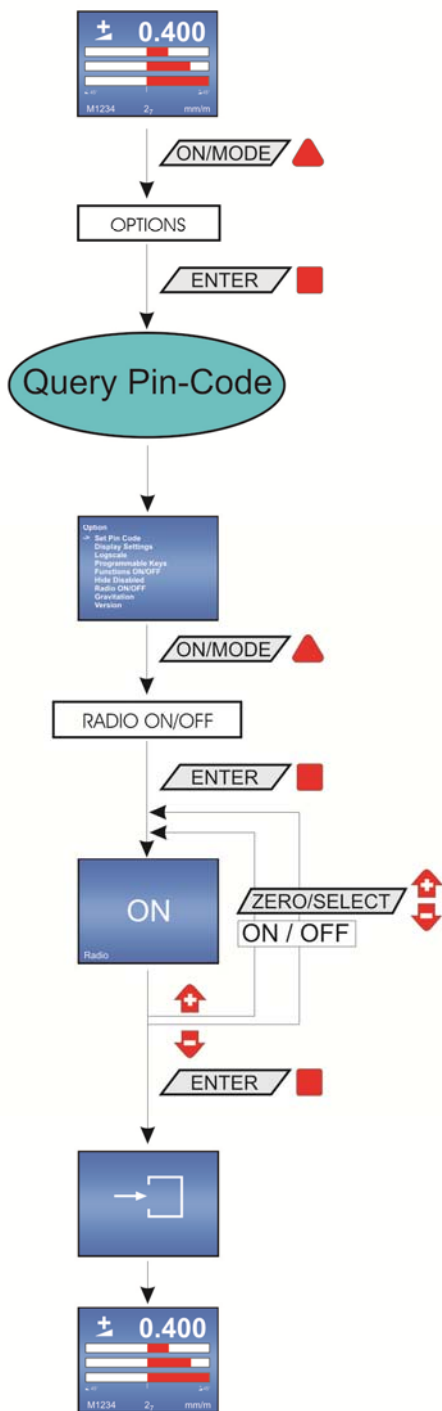

OPTIONS / Auto Address ON/OFF

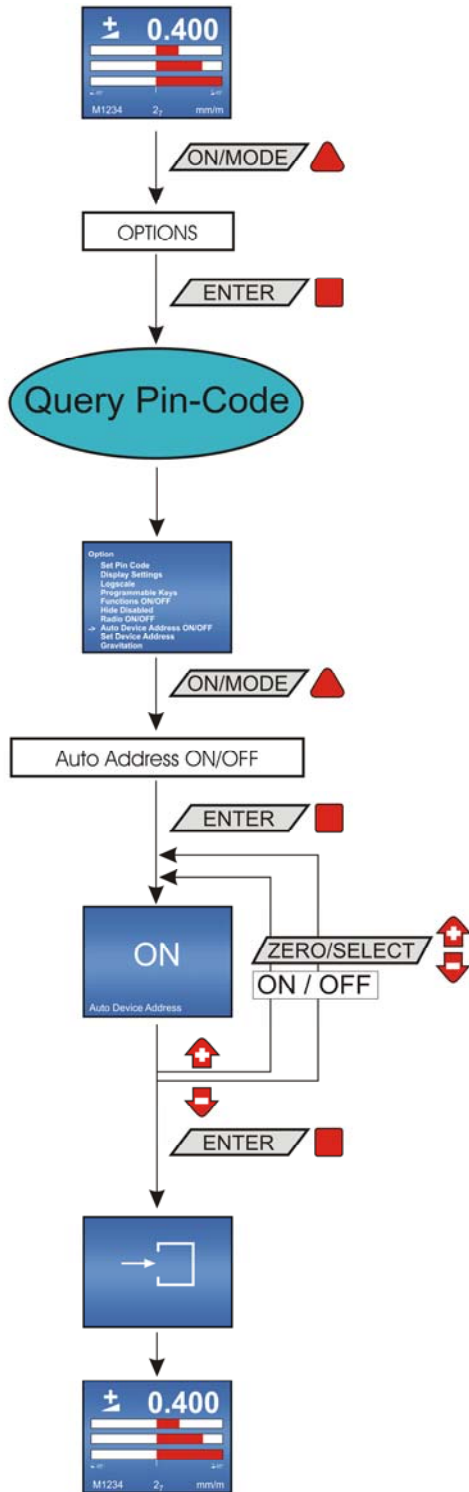

OPTIONS / Set Address

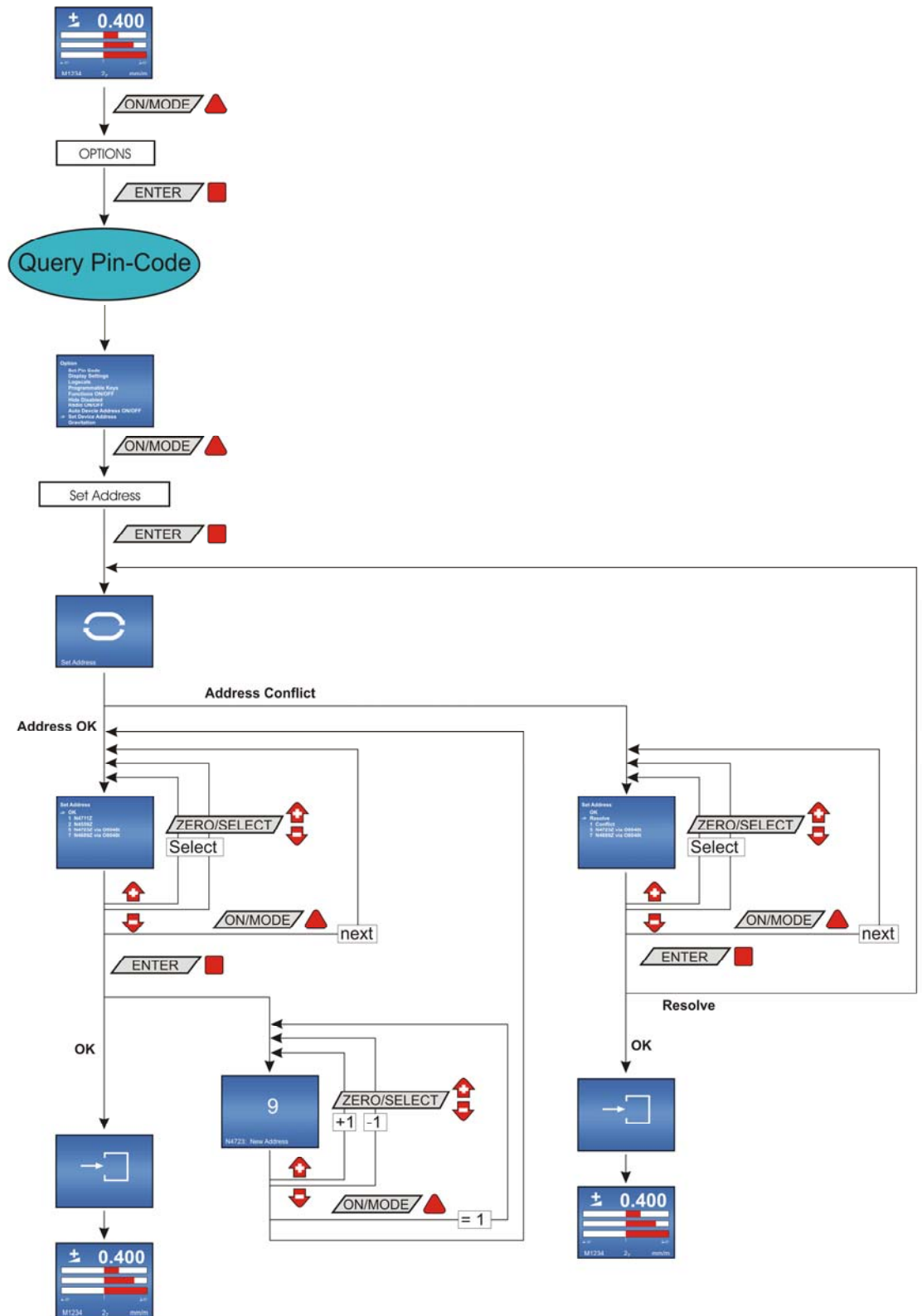

OPTIONS / Local Gravity

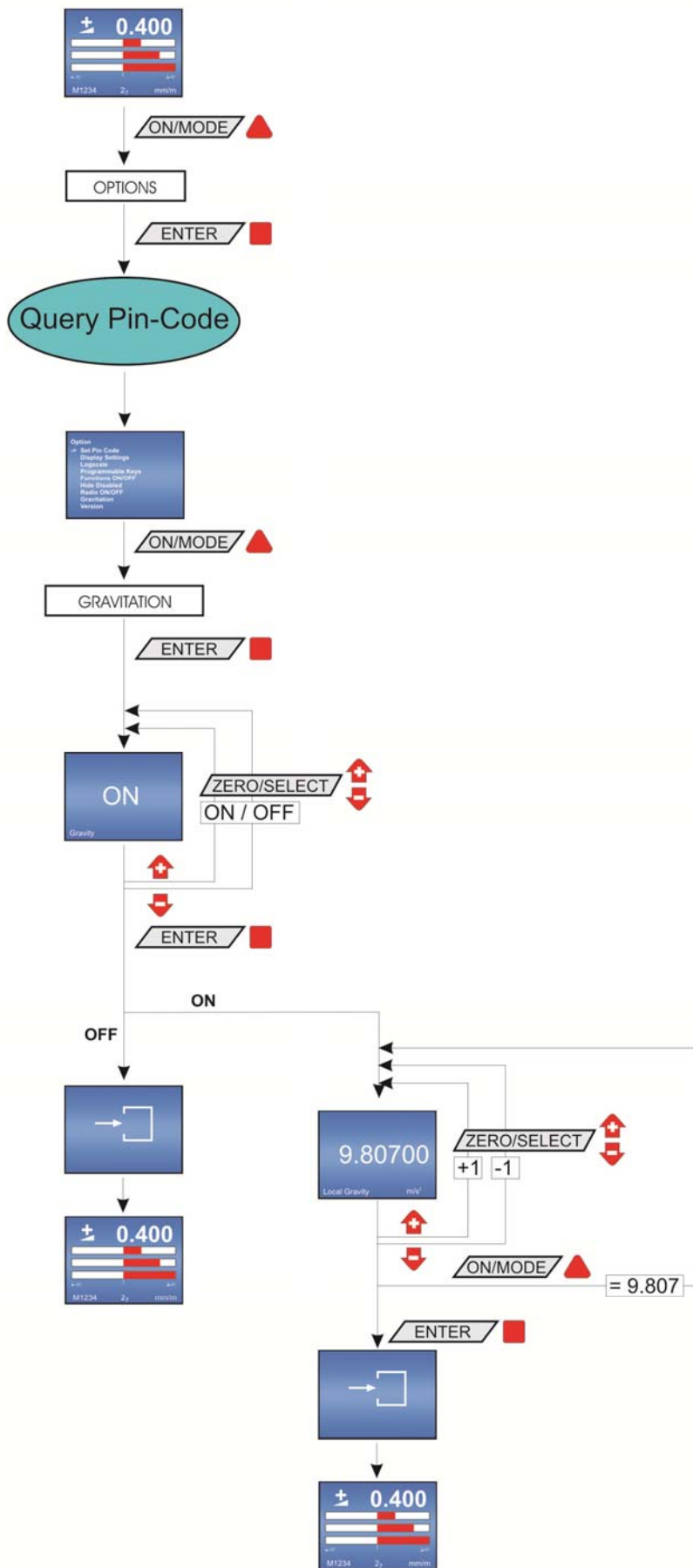

OPTIONS / Version FIRMWARE

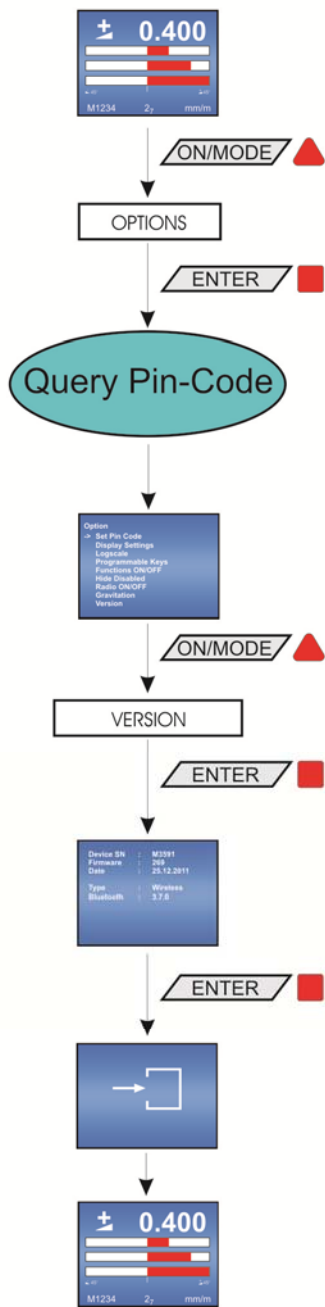

OPTIONEN / Factory Reset

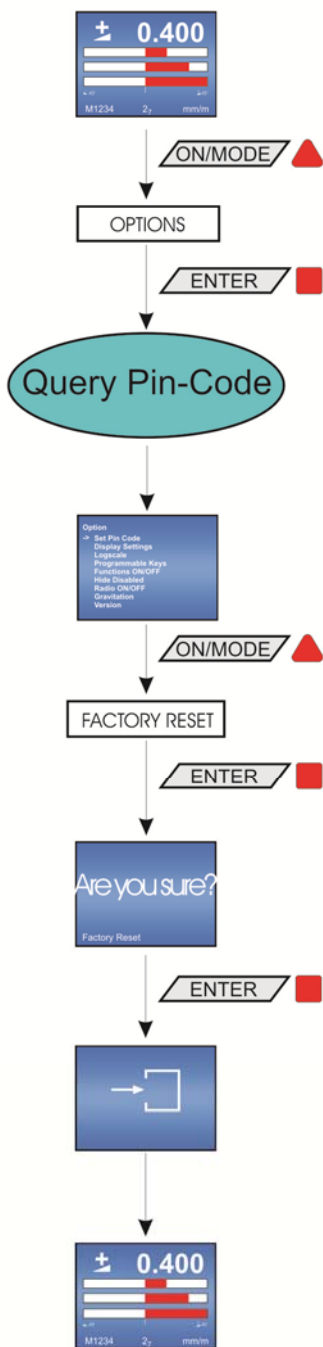

OPTIONS / Self Test

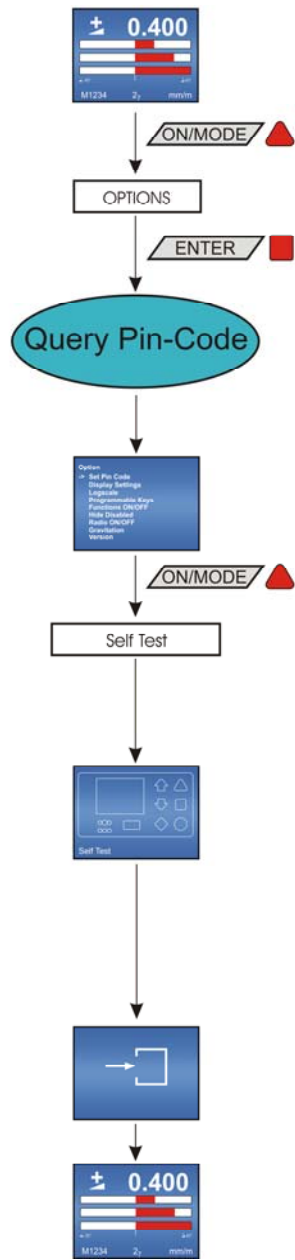

K INDEX

Key word	Chapter	Page
A		
ABSOLUTE MEASUREMENT	4.10.1	48
ABSOLUTE MEASUREMENT / RELATIVE MEASUREMENT	4.10	48
ACCREDITATION BLUETOOTH™ WIRELESS TECHNOLOGY FOR BLUESYSTEM	G	85
ACTIVATE THE FUNCTION KEY ON THE BLUETC	C3	78
ADDITIONAL FUNCTIONS		20
APPENDIX		71
AUTO DEVICEADDRESS ON/OFF	5.8	62
B		
BACKGROUND COLOUR	4.2.3	35
BASICS / INTRODUCTION	1	6
BASICS ANF GENERAL REMARKS ABOUT BLUESYSTEM AND INCLINATION MEASUREMENT	A	71
BATTERIES	2.1	7
BLUETC (TRANSCIVER/CONVERTER) WITH OR WITHOUT RADIO MODULE	6	67
BLUETOOTH EQUIPMENT	G2	86
BRIGHTNESS OF THE DISPLAY	4.2.4	36
C		
CARE AND HANDLING OF THE BATTERIES	F2	84
CHANGING SENSOR ADDRESSES	5.9	62
COMBINE A GROUP OF INSTRUMENTS TO A MEASUREMENT GROUP USING THE FUNCTION „JOIN“ IN RADIO TRANSMISSION MODE	2.4	10
CONNECTING THE BLUEMETER SIGMA	2.3.1	9
CONNECTING THE BLUETC	2.3.2	9
CONNECTING THE INSTRUMENTS	2.3	9
COUNTRY SPECIFIC INFORMATION FOR BLUETOOTH RADIO LINK (>10MW RF-POWER)	G4	87
D		
DESCRIPTION OF THE BLUEMETER SIGMA WITH OR WITHOUT RADIO MODULE	4	27
DESCRIPTION OF THE KEYS AND FUNCTION OF THE BLUELEVEL WITH AND WITHOUT RADIO TRANSMISSION	3	13
DESCRIPTION OF THE VARIOUS KEYS		70
DESCRIPTION OF THE VARIOUS KEYS	3.5.1	21
DESCRIPTION OF VARIOUS DISPLAY FORMS ON THE BLUELEVEL	3.5.2	25
DIFFERENCE BETWEEN THE CONFIGURATION WITH BLUEMETER AND BLUETC	A2	72
DISPLAY	4.2	32
DISPLAY SETTINGS	5.2	58
DISPLAY TYPES	4.2.2	32
E		
EXAMPLE USING THE HYPER TERMINAL OF WINDOWS OR WINDOWS TERMINAL PROGRAM (EXAMPLE IS WIN XP)	B	75
F		
FACTORY RESET	5.12	65
FCC COMPLIANCE	G3	86
FIRMWARE VERSION	C2	77
FLOAT CHARTS OPTIONS	I	102
FLOWCHARTS	H	90
FUNCTION CHECK	5.13	66
FUNCTION HOLD	4.8	47
FUNCTIONAL MENU WITH BLUELEVEL USING THE FUNCTION KEY	3.3	15
FUNCTIONAL MENU WITH BLUETC / STRUCTURE	6.4	69
FUNCTIONS ON THE BLUEMETER SIGMA / OVERVIEW KEYS AND DISPLAY	4.3.1	38
FUNCTIONS ON/OFF	5.5	61
G		
GRAVITATION	5.10	64
GROUPING AND UNHINGING OF A MEASURING GROUP (JOIN/LEAVE)	4.12	53
H		

HIDE DISABLED FUNCTIONS ON/OFF	5.6	61
I		
INDEX / KEYWORDS	K	116
INITIAL STARTUP OF THE BLUETC	6.1	67
INITIAL STARTUP OF THE INSTRUMENTS	2.2	8
INSERTING RESPECTIVELY REPLACEMENT OF BATTERIES IN BLUEMETER SIGMA	2.1.2	7
INSERTING RESPECTIVELY REPLACEMENT OF BATTERIES IN BLUETC	2.1.3	7
INSERTING RESPECTIVELY REPLACEMENT OF BATTERIES IN BLUELEVEL	2.1.1	7
INSTRUMENT'S OVERVIEW	A3	73
INTRODUCTION TO THE BLUESYSTEM	A1	71
K		
KEYS / FUNCTIONS / SHORT DESCRIPTIONS OF EACH SINGLE KEY	4.1.2	30
L		
LOGSCALE	5.3	59
M		
MANUFACTURERS DECLARATION OF CONFORMITY (DoC)	G1	85
MEASURING WITH LIMITS / LIMITS	4.11	51
O		
OPERATING INSTRUCTIONS BLUEMETER SIGMA	4.3	38
OPERATING THE BLUELEVEL	3.5	21
OPERATING THE BLUETC	6.5	70
OPTIONS	5	57
OVERVIEW KEYBOARD AND DISPLAY	4.1.1.1	27
OVERVIEW OF THE BLUETC	6.3	68
P		
PIN-DEFINITION FOR BLUELEVEL + BLUEMETER, BLUELEVEL + BLUEMETER BASIC AND BLUETC	D5	81
PREPARATION AND START-UP OF THE BLUEMETER SIGMA	4.1.1	27
PREPARATION AND STARTUP OF THE MEASURING INSTRUMENTS	2	7
PROCEDURE "JOIN" VIA CABLE CONNECTION	4.12.1	53
PROCEDURE "JOIN" WITH WIRELESS DATA TRANSMISSION	2.4.2	11
PROCEDURE "JOIN" WITH WIRELESS DATA TRANSMISSION	4.12.2	54
PROCEDURE „LEAVE“		11
PROCEDURE FUNCTION „JOIN“	2.4.1	10
PROGRAMMABLE KEYS	5.4	60
R		
RADIO ON/OFF	5.7	62
REAR VIEW	3.2.1	14
REFRESH	4.4	42
RELATIVE MEASUREMENT / REL ZERO	4.10.2	49
RENEWED CONNECTION OF A MEASURING GROUP	2.6	12
RENEWED CONNECTION OF A MEASURING GROUP	4.12.5	55
REPAIR OF MEASURING INSTRUMENTS AND DISPLAY UNITS	E1	82
RESET TO FACTORY PRE-SETTINGS	C1	77
S		
SCALING OF THE DISPLAY	4.2.1	32
SELECTION OF THE FILTER UNDER DIFFERENT MEASURING CONDITIONS / FILTER	4.9	48
SELECTION OF THE MEASURING UNIT / UNIT	4.7	46
SENSOR	4.5	42
SERVICE- AND MAINTENANCE CONTRACTS	E2	83
SERVICE AND REPAIR	E	82
SET ABSOLUTE ZERO (WITH A REVERSAL MEASUREMENT)	4.6.1	44
SET PIN-CODE	5.1	58
SHORT DESCRIPTION OF THE INDIVIDUAL DISPLAY AREAS	4.2.5	37
SPECIAL CASES "JOIN"	2.4.3	12
SPECIAL CASES "JOIN"	4.12.3	55
SPECIAL FUNCTIONS	C	77
STANDARD-UNITS	4.7.1	46

START WITH A CHANGED CONFIGURATION	4.3.2.2	41
START WITH UNCHANGED CONFIGURATION	4.3.2.1	40
STARTING THE BLUEMETER SIGMA	4.3.2	40
START-UP OF THE BLUEMETER SIGMA	4.1	27
STORAGE OF THE INSTRUMENTS	F1	84
STORAGE OF THE INSTRUMENTS / CARE AND HANDLING OF THE BATTERIES	F	84
SWITCHING THE INSTRUMENT ON AND OFF	4.1.1.2	29
T		
TEACH-IN OF THE IR-TRIGGER (ZAPPER)	3.4	20
TEACH-IN OF THE IR-TRIGGER (ZAPPER)	4.13	56
TECHNICAL DATA BLUESYSTEM	D	79
TECHNICAL DATA OF THE BLUELEVEL	D2	79
TECHNICAL DATA OF THE BLUEMETER	D3	80
TECHNICAL DATA OF THE INTERFACE BLUETC	D4	80
TECHNICAL DATA OF THE RADIO MODULES	D1	79
THE BLUELEVEL	3.1	13
THE INSTRUMENTS OF THE BLUESYSTEM - FAMILY IN DETAIL		73
TOP VIEW	3.2.2	14
TYPICAL CONFIGURATIONS WITH BLUETC	6.2	68
U		
UNHINGE AN INSTRUMENT IN THE RADIO MODE FROM A GROUP BY USING THE FUNCTION „LEAVE“	2.5	12
UNHINGE AN INSTRUMENT IN THE RADIO MODE FROM A GROUP BY USING THE FUNCTION „LEAVE“	4.12.4	55
UNITS WITH RELATIVE BASE LENGTH	4.7.2	46
V		
VERSION FIRMWARE	5.11	65
VIEW OF FUNCTIONAL KEYS BLUELEVEL	3.2	14
Z		
ZERO-SETTING / ABSOLUTE ZERO	4.6	44



WYLER AG
Im Hölderli
CH-8405 WINTERTHUR
Switzerland

Tel. 0041 (0) 52 233 66 66
Fax. 0041 (0) 52 233 20 53

Homepage: <http://www.wylerag.com>
E-Mail: wyler@wylerag.com